

Smart choice for power

xantrex

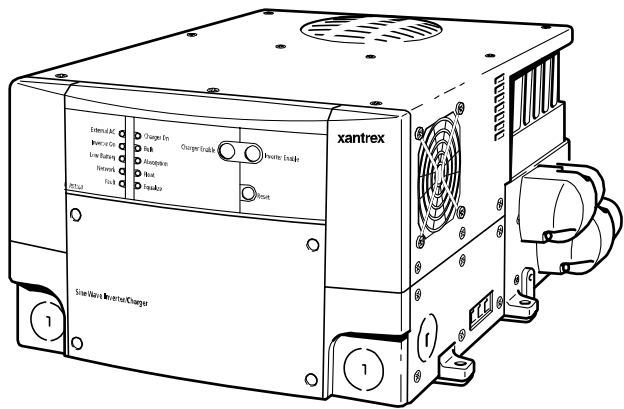

RS3000

Operation Guide

RS3000 Sine Wave Inverter/Charger



www.xantrex.com

RS3000 Sine Wave Inverter/Charger

Operation Guide

About Xantrex

Xantrex Technology Inc. is a world-leading supplier of advanced power electronics and controls with products from 50 watt mobile units to one MW utility-scale systems for wind, solar, batteries, fuel cells, microturbines, and backup power applications in both grid-connected and stand-alone systems. Xantrex products include inverters, battery chargers, programmable power supplies, and variable speed drives that convert, supply, control, clean, and distribute electrical power.

Trademarks

RS3000 Sine Wave Inverter/Charger is a trademark of Xantrex International. Xantrex and Xanbus are registered trademarks of Xantrex International.

Other trademarks, registered trademarks, and product names are the property of their respective owners and are used herein for identification purposes only.

Notice of Copyright

RS3000 Sine Wave Inverter/Charger Operation Guide © April 2007 Xantrex International. All rights reserved.

Disclaimer

UNLESS SPECIFICALLY AGREED TO IN WRITING, XANTREX TECHNOLOGY INC. ("XANTREX")

(a) MAKES NO WARRANTY AS TO THE ACCURACY, SUFFICIENCY OR SUITABILITY OF ANY TECHNICAL OR OTHER INFORMATION PROVIDED IN ITS MANUALS OR OTHER DOCUMENTATION.

(b) ASSUMES NO RESPONSIBILITY OR LIABILITY FOR LOSS OR DAMAGE, WHETHER DIRECT, INDIRECT, CONSEQUENTIAL OR INCIDENTAL, WHICH MIGHT ARISE OUT OF THE USE OF SUCH INFORMATION. THE USE OF ANY SUCH INFORMATION WILL BE ENTIRELY AT THE USER'S RISK.

Date and Revision

April 2007 Rev D

Part Number

975-0170-01-01

Contact Information

Telephone: 1 800 670 0707 (toll free North America)
1 360 925 5097 (direct)

Fax: 1 800 994 7828 (toll free North America)
1 360 925 5143 (direct)

Email: customerservice@xantrex.com

Web: www.xantrex.com

About This Guide

Purpose

The *RS3000 Sine Wave Inverter/Charger Operation Guide* provides explanations and procedures for operating, configuring, and troubleshooting the RS3000 Sine Wave Inverter/Charger (RS3000).

Scope

The guide provides safety guidelines and information about operating, configuring, and troubleshooting the unit. It does not include information for installing the inverter/charger. Refer to the *RS3000 Sine Wave Inverter/Charger Installation Guide*.

The guide also provides general guidelines on batteries; it does not provide details about particular brands of batteries. You need to consult individual battery manufacturers for this information.

Audience

The guide is intended for users who need to configure and operate the RS3000 Sine Wave Inverter/Charger.

Organization

This guide is organized into four chapters and three appendixes.

Chapter 1, “Introduction”, outlines the main performance and safety features of the RS3000 Sine Wave Inverter/Charger. Reading this chapter will give you a clear understanding of the inverter/charger’s capabilities.

Chapter 2, “Operation”, provides information about operating the RS3000. Details are provided on how to read the front panel indicators to monitor the RS3000.

Chapter 3, “Configuration”, explains how to configure the RS3000 from the control panel.

Chapter 4, “Troubleshooting”, explains how to identify and solve problems that can occur with the RS3000.

Appendix A, “Specifications”, provides electrical, physical, and performance specifications for the inverter/charger.

Appendix B, “Battery Charging Reference”, provides information on three-stage charging, two-stage charging, and charging times.

Appendix C, “Terminology”, provides a glossary and a listing of commonly used abbreviations and acronyms.

“Warranty and Return Information” provides the product warranty, explains how to return a product for service, and describes what to prepare for a call to Xantrex Customer Service.

Conventions Used

The following conventions are used in this guide.



WARNING

Warnings identify conditions or practices that could result in personal injury or loss of life.









CAUTION

Cautions identify conditions or practices that could result in damage to the RS3000 or other equipment.

Important: Important notes provide information that is important for you to know. They are not as critical as Cautions or Warnings.

Symbols Used

The following symbols are used on the product labels or in this guide.

	In this guide: Important information, warnings or cautions. On the product: Important information, warnings or cautions with further explanation in the product guides.
	AC – Alternating current
	DC – Direct current
	Warning: Hot surface. Do not touch.
	DC ground connection point
	AC safety ground connection point from incoming AC source
	AC safety ground connection point for AC output (to AC loads)

Related Information

For related materials on this product and its available accessories, see:
RS3000 Sine Wave Inverter/Charger Installation Guide (975-0171-01-01)
System Control Panel Owner's Guide (975-0083-01-01)
Automatic Generator Start Owner's Guide (975-0082-01-01)
Xanbus System Installation Guide (975-0136-01-01)

More information about Xantrex Technology Inc. as well as its products and services, including a complete list of Xanbus-enabled devices, is available at **www.xantrex.com**

Contact Information

Telephone: 1 800 670 0707 (toll free North America)
1 360 925 5097 (direct)

Fax: 1 800 994 7828 (toll free North America)
1 360 925 5143 (direct)

Email: customerservice@xantrex.com

Web: www.xantrex.com

Important Safety Instructions

READ AND SAVE THESE INSTRUCTIONS

The *RS3000 Sine Wave Inverter/Charger Operation Guide* contains important safety instructions.

Before you install and use your RS3000 Sine Wave Inverter/Charger, be sure to read, understand and save these safety instructions and those in the other product guides.

Read all instructions and cautionary markings on the Inverter/Charger, the batteries and all appropriate sections of this guide.



WARNING: Risk of injury or loss of life

The RS3000 Sine Wave Inverter/Charger shall not be used in connection with life support systems or other medical equipment or devices.



WARNING

The following warnings identify conditions or practices that could result in personal injury or loss of life.

1. Use of accessories not recommended or sold by Xantrex Technology, Inc. may result in a risk of fire, electric shock, or injury to persons.
2. The Inverter/Charger is designed to be permanently connected to your AC and DC electrical systems. Xantrex recommends that all wiring be done by a certified technician or electrician to ensure adherence to the local and national electrical codes applicable in your application.
3. To avoid a risk of fire and electric shock, make sure that existing wiring is in good condition and that wire is not undersized. Do not operate the Inverter/Charger with damaged or substandard wiring.
4. To reduce risk of damage and injury, charge only rechargeable lead-acid batteries (flooded, gel, or absorbed glass mat (AGM) types). Other types of batteries may burst, causing personal injury and damage.

5. Do not operate the Inverter/Charger if it has received a sharp blow, been dropped, or otherwise damaged in any way. If the unit is damaged, see the “Warranty and Return Information” section in the *RS3000 Sine Wave Inverter/Charger Operation Guide*.
6. Do not disassemble the Inverter/Charger; it does not contain user serviceable parts. Take it to a qualified service person when service or repair is required. Incorrect reassembly may result in a risk of electrical shock or fire. Internal capacitors remain charged after all power is disconnected. For instructions on obtaining service, see the “Warranty and Return Information” section in the *RS3000 Sine Wave Inverter/Charger Operation Guide*.
7. Do not expose the Inverter/Charger to rain, snow, or water.
8. To reduce risk of electric shock, disconnect all sources of AC and DC power from the Inverter/Charger before attempting any maintenance or cleaning. Turning off controls will not reduce this risk.
9. The Inverter/Charger must be provided with equipment grounding conductors connected to the AC input ground and chassis ground terminals.



CAUTION

Cautions identify conditions or practices that could result in damage to the unit or other equipment.

To reduce the risk of overheating, keep the ventilation openings clear and do not install the Inverter/Charger in a compartment with limited airflow or inadequate clearances around the unit. Refer to the *RS3000 Sine Wave Inverter/Charger Installation Guide* for required clearance.

Explosive Gas Precautions



WARNING: Risk of explosive gases

Working in vicinity of a lead-acid battery is dangerous. Batteries generate explosive gases during normal battery operation. For this reason, it is of utmost importance that you must read this guide and follow its instructions closely each time before you service equipment in the vicinity of the battery.

1. To reduce risk of battery explosion, follow these instructions and those published by the battery manufacturer and manufacturer of any equipment you intend to use in the vicinity of the battery. Review cautionary markings on these products and on the engine.
2. This equipment contains components which tend to produce arcs or spark. To prevent fire or explosion, do not install the inverter/charger in compartments containing batteries or flammable materials or in locations that require ignition-protected equipment. This includes any space containing gasoline-power machinery, fuel tanks, as well as joints, fittings, or other connections between components of the fuel system.

Personal Precautions When Working With Batteries

1. Someone should be within range of your voice or close enough to come to your aid when you work near a lead-acid battery.
2. Have plenty of fresh water and soap nearby in case battery acid contacts your skin, clothing, or eyes.
3. Wear complete eye protection and clothing protection. Avoid touching your eyes while working near batteries.
4. If battery acid contacts your skin or clothing, wash immediately with soap and water. If acid enters your eye, immediately flood the eye with running cold water for at least ten minutes and get medical attention immediately.
5. Never smoke or allow a spark or flame in the vicinity of the battery or the engine.
6. Be extra cautious to reduce risk of dropping a metal tool onto battery. It might spark or short-circuit the battery or other electrical parts that may cause explosion.

7. Remove personal metal items such as rings, bracelets, necklaces, and watches when working with a lead-acid battery. A lead-acid battery can produce a short-circuit current high enough to weld a ring or the like to metal, causing a severe burn.
8. Never charge a frozen battery.
9. If necessary to remove the battery, always remove the grounded terminal from the battery first. Make sure all accessories are off, so as not to cause an arc.
10. Be sure area around battery is well ventilated.
11. Clean battery terminals. Be careful to keep corrosion from coming in contact with your eyes.
12. Study all battery manufacturer's specific precautions such as removing or not removing cell caps while charging and recommended rates of charge.
13. For refillable (flooded) batteries, add distilled water in each cell until the battery acid reaches the level specified by the battery manufacturer. This helps to purge excessive gas from cells. Do not overfill. Carefully follow manufacturer's recharging instructions.

FCC Information to the User

This equipment has been tested and found to comply with the limits for a Class B digital device, pursuant to part 15 of the FCC Rules. These limits are designed to provide reasonable protection against harmful interference when the equipment is operated in a residential environment. This equipment generates, uses and can radiate radio frequency energy and, if not installed and used in accordance with the instruction guide, may cause harmful interference to radio communications. However, there is no guarantee that interference will not occur in a particular installation. If this equipment does cause harmful interference to radio or television reception, which can be determined by turning the equipment off and on, the user is encouraged to try to correct the interference by one or more of the following measures:

- Reorient or relocate the receiving antenna.
- Increase the separation between the equipment and the receiver.
- Connect the equipment into an outlet on a circuit different from that to which the receiver is connected.
- Consult the dealer or an experienced radio/TV technician for help.

Contents

Important Safety Instructions	vii
-------------------------------------	-----

1 Introduction

About the RS3000 Sine Wave Inverter/Charger	1-2
Premium Power and Ease of Use	1-2
How RS3000 Works	1-3
Inverting	1-3
Charging	1-4
Xanbus System	1-5
Xanbus Enabled	1-5
Comprehensive Electronic Protection	1-6
RS3000 Features	1-7
Front Panel Features	1-7
Side Panel Features	1-9
DC Terminal Covers and Battery Temperature Sensor	1-11
DC Terminal Covers	1-11
Battery Temperature Sensor	1-11
System Accessories and Network Components	1-12

2 Operation

Operating the RS3000 with the System Control Panel	2-2
Using the System Control Panel	2-3
On Start Up	2-4
System Start-up Check	2-5
Viewing the Firmware Revision Number	2-5
Operating in Invert Mode	2-6
Load Sense Mode	2-6
Operating Limits for Inverter Operation	2-7
Power Output	2-7
Operating in Charger Mode	2-8
Charger Operation with Battery Temperature Sensor	2-9
Operating in Equalization Mode	2-10
Equalizing Batteries	2-11
Terminating the Equalization Process	2-11
Operating Limits for Charger Operation	2-12
Power Share	2-12
Monitoring the RS3000 Indicator Lights	2-13

Faults and Warnings	-2-14
Monitoring Status Messages on the System Control Panel	-2-14
System Modes	-2-15
Operating Mode	-2-16
Power Save Mode	-2-16
Safe Mode	-2-17
Putting the System into Safe Mode	-2-18
Hibernate Mode	-2-20

3 Configuration

General Configuration Information	3-2
System Control Panel	3-2
System Menu Map	3-3
Viewing the System Screen	3-4
Viewing the Select Device Menu	3-4
Selecting the RS3000 from the Select Device Menu	3-5
Selecting the RS3000 Basic Menu	3-5
Selecting the RS3000 Advanced Menu	3-6
Returning to RS3000 Basic Menu	3-7
Selecting and Adjusting the Configurable Settings	3-8
Selecting the Default Settings	3-8
RS3000 Menu Structure	3-9
RS3000 Device Menu	3-10
Modes	3-10
Battery	3-11
AC Input1 and AC Input2	3-11
AC Out	3-11
RS3000 Menu (Basic)	3-12
Inverter	3-12
Charger	3-12
Power Share	3-13
Equalize	3-14
Batt Type	3-16
Batt Size	3-17
Clear Faults	3-17
RS3000 Menu (Advanced)	3-18
Inverter	3-18
Charger	3-18
Power Share	3-18
Configure Inv/Chg (Configure Inverter/Charger)	3-18
Equalize	3-19
Load Sense	3-19

Clear Faults	3-19
View Device Info	3-19
Basic Menu	3-19
Sub-Menus	3-20
Configure Inv/Chg Menu (Configure Inverter/Charger Menu)	3-20
Max Chg Rate	3-20
Lo DC Volt	3-21
Batt Type	3-21
Batt Size	3-21
Sense Below	3-21
Sense Interval	3-22
Cfg AC Limits (Configure AC Limits)	3-22
# Chg Stages	3-22
Eqz Volts	3-23
Force Charge	3-23
Cfg AC Limits (Configure AC Limits)	3-24
Lo AC Volt	3-24
Lo AC Freq	3-25
Hi AC Volt	3-25
Hi AC Freq	3-26
View Device Info (View Device Information)	3-27
View Fault Log	3-27
View Warning Log	3-27
View Event Log	3-28
Restore Defaults	3-28

4 Troubleshooting

Faults and Warnings	4-2
Fault Types	4-2
Warning Types	4-3
Troubleshooting Reference	4-4
General Troubleshooting Guidelines	4-5
Warning Messages	4-7
Fault Messages	4-10
Inverter Applications	4-16
Resistive Loads	4-16
Motor Loads	4-16
Problem Loads	4-16
Very Small Loads	4-16
Fluorescent Lights & Power Supplies	4-17
Clocks	4-17
Searching	4-17

A Specifications

Inverter Specifications	A-2
Charger Specifications	A-3
Transfer and General Specifications	A-4
Environmental Specifications	A-4
Physical Specifications with Projections	A-5
Regulatory Approvals	A-5
Fan Operation	A-5
Invert Power Derating vs Ambient Temperature	A-6
Charger Mode	A-6

B Battery Charging Reference

Charging Algorithms (Formulas)	B-2
Battery Type	B-2
Charge Algorithm Stages	B-2
Three-Stage charging	B-2
Bulk Charge	B-3
Absorption Charge	B-3
Float Charge	B-4
Equalization Charge	B-4
Two-Stage Charging	B-5
Charge Algorithm Graph	B-5
Charge Algorithm Definitions	B-5
Battery Charger Interruption	B-6

C Terminology

Glossary	C-2
Abbreviations	C-6

Warranty and Return Information

Warranty	WA-1
Return Material Authorization Policy	WA-3
Return Procedure	WA-3
Out of Warranty Service	WA-4
Information About Your System	WA-4

Index

Figures

Figure 1-1	Typical Xanbus System Diagram	1-5
Figure 1-2	Front Panel of the RS3000	1-7
Figure 1-3	Front Panel Lights and Buttons	1-8
Figure 1-4	Completed Connections on Side Panel	1-9
Figure 1-5	Battery Terminal Covers	1-11
Figure 1-6	Battery Temperature Sensor	1-11
Figure 2-1	System Control Panel	2-3
Figure 2-2	Battery Temperature Sensor	2-9
Figure 2-3	System Control Panel	2-15
Figure 2-4	Operating Mode	2-16
Figure 2-5	Power Save Mode	2-17
Figure 2-6	Select Device Menu	2-18
Figure 2-7	System Settings Menu	2-19
Figure 2-8	Safe Mode	2-19
Figure 3-1	System Menu Map	3-3
Figure 3-2	RS3000 Float System Screen (Example)	3-4
Figure 3-3	Select Device Menu	3-5
Figure 3-4	RS3000 Menu in Invert Mode	3-5
Figure 3-5	Highlighting System on the Select Device Menu	3-6
Figure 3-6	Highlighting Global Menus	3-7
Figure 3-7	Returning to RS3000 Basic Menu	3-7
Figure 3-8	RS3000 Menu Structure — Overview	3-9
Figure 3-9	Equalize On	3-14
Figure 3-10	Equalize Confirmation Warning	3-14
Figure 3-11	Equalization System Home Screen	3-15
Figure 3-12	Equalization Cancellation Warning	3-16
Figure 3-13	RS3000 Device Info Menu	3-27
Figure 3-14	Event Log	3-28
Figure 3-15	Restore Defaults Warning	3-29
Figure A-1	Inverter Output Power vs Ambient Temperature	A-6
Figure B-1	Three-Stage Charging Profile	B-5

1

Introduction

Congratulations on your purchase of the RS3000 Sine Wave Inverter/Charger.

The RS3000 has been designed to give you premium power, ease of use, and outstanding reliability.

Please read this chapter to familiarize yourself with the main performance and protection features of the RS3000.

About the RS3000 Sine Wave Inverter/Charger

The RS3000 Sine Wave Inverter/Charger is a convenient combination of an inverter, multistage battery charger, and transfer switch in one electronic device.

- As an inverter, the RS3000 provides sine wave power for your microwave, entertainment system, computer, and other loads. This power is identical to the AC source provided from the utility grid (power company).

Some of the benefits of sine wave power include consistent cooking in your microwave, handling of sensitive loads such as your TV set, dimmer switches, and appliances with speed controls.

- As a 150 amp power-factor corrected charger, the RS3000 quickly and efficiently recharges your batteries.
- Unique split phase design transfers up to 12 kVA of incoming qualified AC power.

Premium Power and Ease of Use

For managing your onboard power system, the RS3000 provides superior features and rugged durability combined with ease of use:

- Produces 120 volts AC at up to 3000 watts, with 7500 watt surge for 5 seconds
- Three-stage charge with 150 amps of output and charge formulas for flooded, gel, and AGM deep cycle batteries plus equalization for flooded batteries
- Sine wave output powers sensitive entertainment electronics
- Split phase input transfers two legs of 50 amps to make full use of available AC power
- Easy-to-read indicator lights on the front panel
- Automatic cooling fans
- Power sharing reduces charging current to prevent tripping of AC input breaker.

How RS3000 Works

The RS3000 is designed to:

- invert
- charge
- accept both split phase and dual input. See “Glossary” on page C–2 for a definition of these terms.

With AC input available from the utility grid or a generator, power is passed through the RS3000 Sine Wave Inverter/Charger to operate connected AC loads. The remaining AC power not used by loads is converted to DC power and used to charge batteries.

If AC input power becomes disconnected, fails, or falls out of specification and is no longer qualified as good AC, a quick transfer takes place and the RS3000 begins converting DC power from the batteries into AC power, to continue to supply power to the AC loads.

Inverting

The RS3000’s inverting function:

- produces 120 volts AC from your batteries at up to 3000 watts with 7500 watts of surge power to start loads like pumps and refrigerators.

To prevent power being drawn needlessly from the batteries, the RS3000 has included the load sensing feature.

Load Sense Mode To reduce battery draw, you can turn on Load Sense mode with the System Control Panel. In Load Sense mode, the inverter periodically sends out a search pulse to see whether a load is present. If it finds a load, the inverter/charger will turn on. If no load is found, then the inverter continues in Load Sense mode, which reduces the inverter draw from the battery to a minimum.

In Load Sense mode, there’s a short delay—up to the interval you’ve set—between the time you turn on a load and the time the inverter/charger delivers power. Load Sense mode can be disabled at any time if you find the delay to be inconvenient.

Charging

The RS3000's charging function:

- produces 150 amps to charge your batteries
- equalizes flooded, lead acid batteries.

Built-in Charge Formulas For the unit to perform at the highest level, the batteries must be charged correctly. The RS3000 has optimized algorithms for flooded, gel, and AGM batteries.

Battery Temperature Sensor Since battery temperature is a key factor in correct charging, the charging formula must be adjusted (automatically and in real time) according to the actual battery temperature to ensure that batteries are fully charged, but not overcharged. For this reason, Xantrex® has included a battery temperature sensor with your RS3000 and has temperature compensated the charge formula.

Manual Equalization Over a period of time, the cells in a flooded battery can develop uneven chemical states. This can result in a weak (undercharged) cell which, in turn, can reduce the overall capacity of the battery. To improve the life and performance of a non-sealed, flooded battery, the RS3000's multi-stage charging cycle includes a manual equalize mode that can be used, if recommended by the battery manufacturer.

Dead Battery Charging Another feature that the RS3000 includes is dead battery charging. The RS3000—unlike many chargers—has the ability to recharge batteries even if the battery voltage is very low.

Load Management The RS3000 has a built-in transfer relay that connects your inverter output or AC input from the utility grid or generator to your loads. Because the usual AC power sources such as campground outlets or small generators often have limited current availability, having the capability to manage your AC loads is extremely valuable. The RS3000 provides a number of features to facilitate this:

- The charger is power factor corrected to use AC current as efficiently as possible and only requires 22 amps to provide rated charger output. Minimizing the AC current used by the charger means more current is available for your AC loads.
- RS3000 has a power share feature which prioritizes your AC loads by reducing the charge current and maintaining the total input current to less than your breaker setting or the breaker setting.
- Occasionally, AC input sources have low voltage. To avoid loading these weak sources any further, the charger automatically reduces its AC current draw as the AC voltage approaches the minimum acceptable level.

Xanbus System

The Xanbus® system includes the RS3000 and other Xanbus-enabled devices. The RS3000 is the device in a Xanbus system that typically provides network power—800 mA at 15 volts DC. All of the Xanbus-enabled devices, such as the RS3000, the System Control Panel (SCP), and the Automatic Generator Start (AGS) are able to communicate their settings and activity to each other. See Figure 1-1.

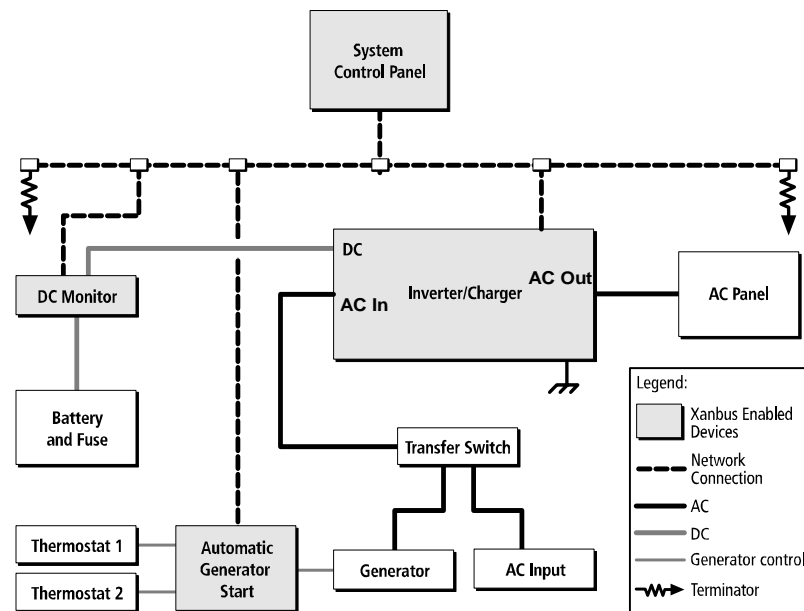

Figure 1-1 Typical Xanbus System Diagram

Xanbus Enabled

The Xanbus-enabled designation means that this product works on a Xanbus network. Xanbus-enabled products are:



- Easy to use. The Xanbus network simplifies operation and automates routine tasks.
- Reliable. Software control eliminates analog signalling errors.
- Accurate. Digital information is less susceptible to interference and line loss.
- Upgradeable. Software upgrades mean your purchase will remain up to date.

For detailed instructions and a complete list of Xanbus-enabled devices, visit www.xantrex.com

Comprehensive Electronic Protection

RS3000 is approved to meet a number of safety standards including UL 458 and CSA C22.2 No. 107.1. See “Regulatory Approvals” on page A–5 for more information.

RS3000 is equipped with numerous protection features to ensure safe operation.

Protection feature	This feature...
Battery over-voltage protection	Keeps the battery voltage from getting too high in charge mode. Shuts the inverter off in invert mode.
Battery under-voltage protection	Prevents inverter from discharging your batteries too low. The inverter doesn’t run if battery voltage is too low.
Over-temperature protection	Protects the unit from overheating by either derating (charge mode) or by shutting down (invert mode). See “Invert Power Derating vs Ambient Temperature” on page A–6.
Automatic overload protection	Protects the unit from excessive loads. The unit will provide 7500 watts (2.5 times of the rated load) for up to 5 seconds, and then protect itself by shutting down. See “Inverter Specifications” on page A–2 for more information.
Short circuit protection	Protects the unit by shutting it down.

RS3000 Features

Front Panel Features

Before you begin to operate the RS3000, review the front panel features shown in Figure 1-2 and described in Table 1-1. A detailed view of the lights and buttons on the front panel is shown in Figure 1-3 and described in Table 1-2.

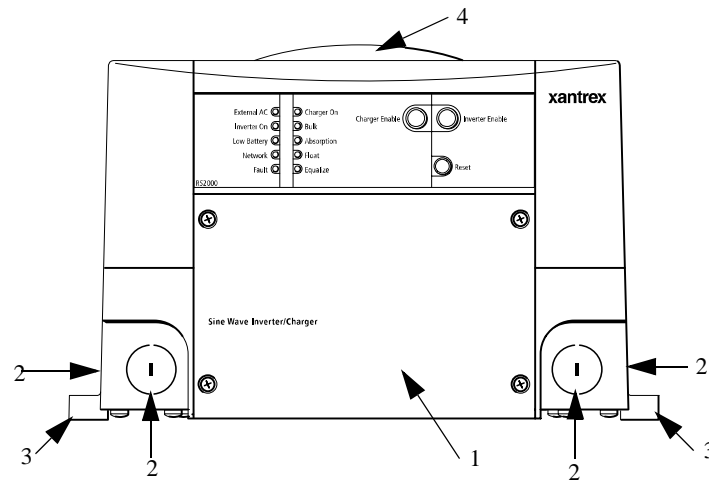

Figure 1-2 Front Panel of the RS3000

Table 1-1 Front Panel Features

Feature	Description
1	AC wiring compartment access panel provides access to the terminal block for wiring the AC input and AC output.
2	AC knockouts provide access for AC input and AC output wiring. A total of four knockouts are provided on the unit: two on the front and one on each side (not shown).
3	Mounting flanges are used for mounting the unit. A total of six flanges are provided on the unit.
4	<p>Fans are used to keep the unit cool.</p> <ul style="list-style-type: none"> The top external fan is an intake fan. The top internal fan (not shown) is an exhaust fan. <p>Both of these fans activate when the internal temperature of the inverter/charger increases. The fan speed varies with the internal temperature and turns off when the inverter/charger cools down. (This internal temperature may be caused by heat in the inverter/charger or by high ambient temperature.)</p> <ul style="list-style-type: none"> The bottom internal fan (not shown) is an exhaust fan and runs continuously if the unit is inverting or charging.

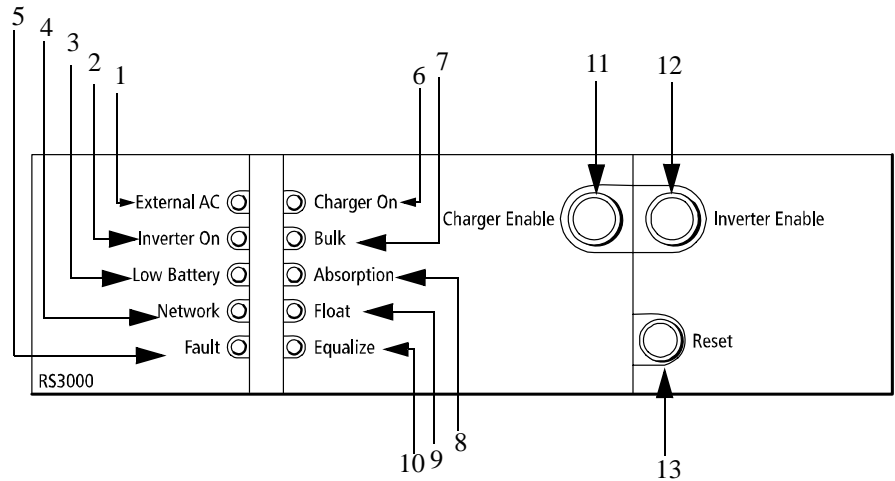

Figure 1-3 Front Panel Lights and Buttons

Table 1-2 Description of Front Panel Lights and Buttons

Feature	Description
1	External AC light illuminates when you are connected to an AC source like the utility grid or a generator and the AC is qualified.
2	Inverter ON light illuminates when the RS3000 is operating in invert mode.
3	Low Battery light illuminates when the battery voltage is low.
4	Network light illuminates when there is activity on the network.
5	Fault light illuminates if a fault condition occurs.
6	Charger ON light illuminates when the RS3000 is in charge mode and is producing DC output to charge your batteries.
7	Bulk light illuminates when the charger is in the bulk stage of battery charging.
8	Absorption light illuminates when the charger is in the absorption stage of battery charging.
9	Float light illuminates when the charger is in the float stage of battery charging.
10	Equalize light illuminates when the unit is equalizing the batteries.
11	Charger Enable button toggles between enable (On) and disable (Off). The Charge Enable button illuminates when the charger is enabled and it can produce DC output to charge your batteries. When the charger is disabled, it does not produce DC output to charge your batteries, but still passes AC input through to AC loads (if present).
12	Inverter Enable button toggles between enable (On) and disable (Off). The Inverter Enable button illuminates when the inverter is enabled and it can produce AC output to run your AC loads. When the inverter is disabled, it does not produce AC output to run your loads.
13	Reset button is used for several functions: to reset after a fault, to perform a power on reset, to wake the RS3000 from Power Save mode or Hibernate mode. See “Operating in Invert Mode” on page 2–6 for a description of the different modes.

Side Panel Features



CAUTION: Equipment Damage

Connect only to other Xanbus compatible devices.

Although the cabling and connectors used in this network system are the same as Ethernet connectors, **this network is not an Ethernet system**. Equipment damage may result from attempting to connect two different systems.

For your reference, the side panel features with all connections completed is shown in Figure 1-4.

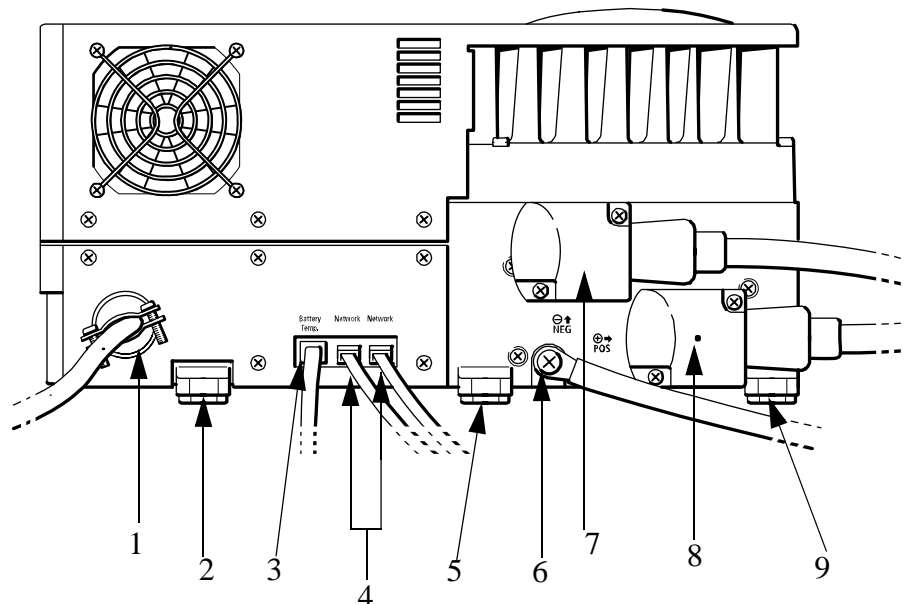

Figure 1-4 Completed Connections on Side Panel

Table 1-3 Description of Side Panel Features

Feature	Description
1	AC knockout provides access for AC input and AC output wiring (shown with strain-relief clamp installed). There are four knockouts on the unit: two on the front and two on the side.
2, 5, 9	Mounting flanges are used for mounting the unit. A total of six flanges are on the unit.
3	Battery temperature sensor jack provides connection for the battery temperature sensor.

Table 1-3 Description of Side Panel Features

Feature	Description
4	Dual network jacks provide connection for network-enabled devices. (The number of connections depends on your layout. Your connections may not be the same as shown here.)
6	Chassis ground point connects the chassis of the RS3000 to your system's chassis grounding point.
7 & 8	DC terminals – negative (black) (7) and positive (red) (8) —shown here with DC covers on.

DC Terminal Covers and Battery Temperature Sensor

DC Terminal Covers

Two covers are supplied to prevent accidental contact with the cabling connectors after installation. The red cover is for the positive cabling terminal, and the black cover is for the negative cabling terminal.

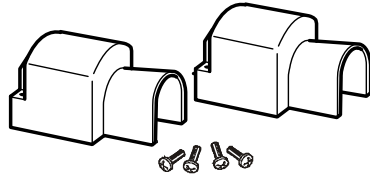

Figure 1-5 Battery Terminal Covers

Battery Temperature Sensor

The battery temperature sensor continuously measures the temperature of the battery and adjusts the charger output for a more accurate, temperature-compensated charge.

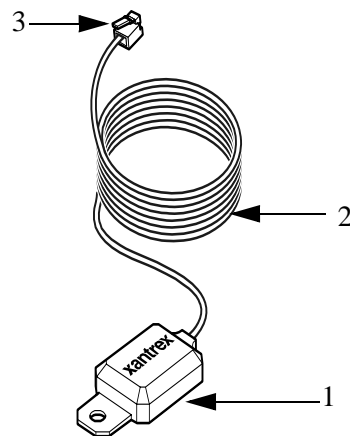

Figure 1-6 Battery Temperature Sensor

Table 1-4 Description of Battery Temperature Sensor Features

Feature	Description
1	Sensor can be mounted on the side of the battery case or on the negative battery terminal.
2	Sensor cable is 25 feet (7.6 meters).
3	Connector plugs into the Battery Temp. jack (battery temperature sensor) on the RS3000.

System Accessories and Network Components

System accessories can be used with the RS3000 in a Xanbus system. The System Control Panel (SCP) provides configuration and monitoring capability for Xanbus-enabled devices such as the RS3000. Automatic Generator Start (AGS) automatically starts and stops your generator.

Table 1-5 provides the part numbers for the system accessories.

Table 1-5 System Accessories

Accessory	Part number
System Control Panel (SCP)	809-0910
Automatic Generator Start (AGS)	809-0915

Consult with your local system designer to determine what network components will be needed for your specific installation. Table 1-6 provides a list of network components and part numbers. Pre-made cables are available in standard lengths ranging from 3 feet to 75 feet.

Table 1-6 Network Components and Part Numbers

Network Component	Part Number
Network termination — Male (2 per pack)	809-0901
3-way network connector	809-0903
Network termination — Female (2 per pack)	809-0905
Network cable 3 ft. (0.9 m)	809-0935
Network cable 5 feet (1.5 m)	809-0936
Network cable 7 feet (2.0 m)	809-0937
Network cable 10 feet (3.0 m)	809-0938
Network cable 14 feet (4.3 m)	809-0939
Network cable 25 feet (7.6 m)	809-0940
Network cable 50 feet (15.2 m)	809-0941
Network cable 75 feet (22.9 m)	809-0942

These accessories and network components are available from any authorized Xantrex dealer or at www.xantrex.com. Detailed information on planning and installing your network is available in the *Xanbus System Installation Guide*. This guide is available for downloading at www.xantrex.com

2

Operation

Chapter 2, “Operation” contains detailed information and procedures for using your RS3000.

If you’re using the System Control Panel to operate or monitor the status of the unit, also refer to the *System Control Panel Owner’s Guide*.



WARNING: Restrictions on use

RS3000 Sine Wave Inverter/Charger shall not be used in connection with life support systems or other medical equipment or devices.



CAUTION

Read this chapter before operating the RS3000 Sine Wave Inverter/Charger.

Operating the RS3000 with the System Control Panel

The System Control Panel (SCP) provides operating, configuration, and monitoring capability for your Xanbus system.

The System Control Panel:

- Monitors activity throughout your onboard power system.
- Displays the latest information about your inverter/charger, battery charge level, battery charge output, and generator start and stop activity.
- Displays the settings for each Xanbus-enabled device in the system.
- Enables you to adjust the settings for each Xanbus-enabled device in the system.
- Preserves all of its settings if system power is interrupted. After power is restored, you don't have to reconfigure the SCP or any of the Xanbus-enabled devices connected to it.

This section provides information on operating the RS3000 with the System Control Panel. Please refer to the *System Control Panel Owner's Guide* for complete information on using the System Control Panel.

Important: Any RS3000 setting changed from the System Control Panel will be saved in the SCP if the unit is shut down by selecting Power Save mode, Safe mode or Hibernate mode. See "Operating in Invert Mode" on page 2-6 for more information about the different types of modes.

Using the System Control Panel

	The System Control Panel has important features which you'll want to be familiar with, as shown in Figure 2-1.
Display screen	System information is shown on the display screen with an adjustable backlight.
Indicator lights	Four indicator lights on the front panel indicate the operating status of the Xanbus system.
Push buttons	Four push buttons allow you to select device menus and change or display settings. The red System button toggles the System Control Panel and Xanbus-enabled devices between Operating mode and Power Save mode. For more information on the different system modes, see "Operating in Invert Mode" on page 2-6.

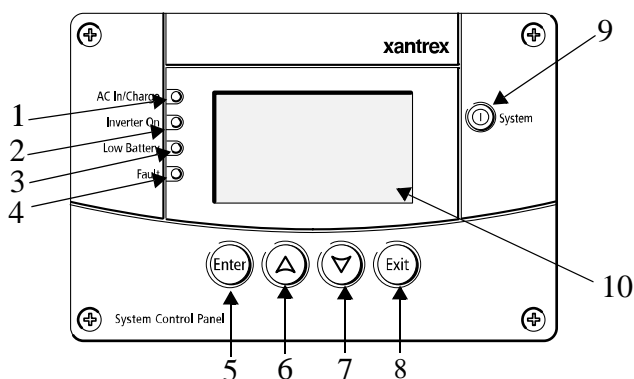

Figure 2-1 System Control Panel

Table 2-1 System Control Panel Features and Buttons

Feature	Description
1	AC In/Charge light indicates that qualified AC is present at the input of an inverter/charger. When the RS3000 is connected to a qualified AC source like the utility grid or a generator, this light on the System Control Panel illuminates.
2	Inverter On light illuminates when the RS3000 is enabled (turned on).
3	Low Battery light illuminates when the battery voltage on the RS3000 is low.

Table 2-1 System Control Panel Features and Buttons

Feature	Description
4	Fault light indicates a condition that requires user attention and intervention. The Fault light illuminates when any Xanbus-enabled device connected to the network is in fault. See “Faults and Warnings” on page 4–2 for the definitions of a fault and warning.
5	Enter button <ul style="list-style-type: none"> • Confirms selection of a menu item. • Moves you to the next screen.
6	Up arrow button <ul style="list-style-type: none"> • Scrolls up one line of text. • Increases a selected value.
7	Down arrow button <ul style="list-style-type: none"> • Scrolls down one line of text. • Decreases a selected value.
8	Exit button <ul style="list-style-type: none"> • Cancels selection of a menu item. • Returns you to the previous screen.
9	System button: <ul style="list-style-type: none"> • Toggles all Xanbus-enabled devices on the system between Operating mode and Power Save mode. See “Operating in Invert Mode” on page 2–6.
10	Screen displays menus, settings, and system information.

On Start Up

When the RS3000 is powered up or has been reset, all of the front panel lights illuminate and remain on for a minimum of five seconds. After five seconds, the lights remain illuminated until the front panel has status information for all the lights.

The RS3000 inverter is disabled every time the RS3000 is powered up. After powerup, the Inverter Enable button or the System Control Panel can be used to enable or disable the inverter. The powerup behaviour of the RS3000 charger is determined by the 'Force Charge' setting (see page 3–23).

When a function is enabled, it is allowed to occur but other conditions may have to be met before the function is activated or turned on. For example, the charger function on the RS3000 may be enabled, but it will not charge unless qualified AC power is present.

System Start-up Check

**WARNING**

Review the “Important Safety Instructions” on page vii before operating the inverter/charger.

To test inverting and charging from the RS3000 front panel:

1. Disconnect AC power from inverter input by opening the breaker or disconnect. Press the Inverter Enable button on the RS3000. The Inverter On light illuminates.
2. Place a load on the inverter. For example, plug a 100 watt light bulb into an outlet that the inverter is powering and make sure it works. The inverter should run the load using battery power.
3. To test the charger, reconnect the AC input power to allow AC to the AC input. The Charger On light should illuminate after a brief delay. Any AC loads previously powered by the inverter will also work at this time.
4. Remove the AC input power. The inverter/charger should transfer to invert mode immediately. (The transfer relay will make a clicking sound and the Inverter On light will illuminate.) Loads should continue to operate uninterrupted.

If any part of this test fails, determine the cause before using the unit. Consult the “Troubleshooting” chapter starting on page 4–1.

Viewing the Firmware Revision Number

You may need to view the firmware revision number of the RS3000 when troubleshooting the unit with authorized service personnel.

To view the firmware revision number:

1. On the Select Device menu, use the down arrow button to highlight System and press Enter.
The System Settings menu appears.
2. Press the down arrow button to highlight View Device info and press Enter.
The Device Info screen appears.
3. Press the down arrow button until the RS3000 screen appears.
The number opposite “F/W Rev.” is the firmware revision number.
4. Press Exit to return to the System Settings menu.

Operating in Invert Mode



WARNING

Review the “Important Safety Instructions” on page vii before operating the inverter/charger.

Once the inverter/charger is installed, you can operate it in invert mode.

To operate in invert mode from the front panel:

1. Press the Inverter Enable button on the RS3000.
2. If external AC is present, the External AC light illuminates. If AC is present and you want to operate the inverter, remove AC so the inverter turns on.

Once the Inverter On light is on, the RS3000 inverter is ready to deliver AC power to the loads.

- ◆ To operate the inverter with the System Control Panel, refer to Chapter 2, “Using the System Control Panel”.

Important: If you are having problems with any of your loads, refer to “Inverter Applications” on page 4–16.

Load Sense Mode

The load sense mode of the RS3000 reduces battery power consumption in order to conserve battery capacity.

When the inverter is enabled, the inverter/charger can be configured to search for an acceptable AC load. (It does this when you enable (turn on) “Load Sense” on the RS3000 Advanced Menu on the System Control Panel and set the load sense power threshold “Sense Below.”)

The inverter output turns off if the unit doesn’t detect a load that meets the load sense parameters. When an acceptable load is detected, the inverter output is turned on and provides continuous output power. When the loadsense feature is disabled (turned off), the inverter is continuously on.

The unit will “sleep” if it doesn’t detect a load that meets the load sense parameters. If a load exceeds the “Sense Below” threshold set in the RS3000 advanced menu, the RS3000 will “wake up” and deliver full power to the load.

Operating Limits for Inverter Operation

Power Output

Temperature

The RS3000 produces 120 volts AC at up to 3000 watts. The RS3000 can deliver this power in an ambient (surrounding) temperature up to 122 °F (50 °C). In higher ambient temperatures, if the loads draw full power for an extended period of time, the unit may shut down to protect itself against overheating.

As with all inverters, the amount of continuous power that the RS3000 can deliver without overheating is limited by the ambient air temperature. The RS3000 will operate and deliver its continuous power rating at higher temperatures, but the ambient temperature as well as the input voltage from the battery will limit the extent to which the unit can run continuously.

The RS3000 has 7500 watt surge for five seconds. Operating the inverter/charger in conditions outside of power and temperature limits, however, will result in thermal shutdown and/or significantly decreased performance. In addition, operation in this range is outside the ratings covered by the regulatory approvals of the product. See “Invert Power Derating vs Ambient Temperature” on page A-6.

Difficulty on starting loads

The inverter/charger should be able to operate all AC loads rated at or below its power rating. Some high horsepower induction motors used in pumps and other motor-operated equipment require very high surge currents to start, and the inverter/charger may have difficulty starting these loads. See “Inverter Applications” on page 4-16.

If you have problems starting certain loads, ensure that:

- the battery connections are tight and clean
- the DC cabling is no longer than the recommended length. Refer to the *RS3000 Sine Wave Inverter/Charger Installation Guide* for this information.
- the AC wiring is of recommended size. Refer to the *RS3000 Sine Wave Inverter/Charger Installation Guide* for this information.
- the battery is of sufficient capacity and is fully charged.

Operating in Charger Mode



WARNING: Explosive Gases

Review the “Important Safety Instructions” on page vii before operating the inverter/charger. During charging, batteries may generate explosive gases. Thoroughly ventilate the areas around the batteries and ensure that there are no sources of flames or spark in the vicinity.

Study all battery manufacturer’s precautions such as removing or not removing cell caps while charging and the recommended rates of charge.

Important: If you are charging a non-sealed battery, ensure there is sufficient distilled water in each cell. The battery acid should be at the level specified by the battery manufacturer. This helps prevent over-heating and purges excessive gases from the cells. Do not overfill. For a battery without cell caps, follow the manufacturer’s recharging instructions carefully.

To operate the RS3000 in charger mode from the front panel:

1. Connect AC input power.

The charger automatically starts up when qualified AC power is connected if the charger is enabled, or the charger is disabled but the Force Charge enable override is On. See “Force Charge” on page 3–23.

- The batteries are charged according to the two-stage or three-stage formula you have selected on the System Control Panel. (See “Battery Charging Reference” on page B–1 for more information on two-stage or three-stage charging.)
 - You can interrupt the charge cycle any time you desire by disabling the charger from the System Control Panel or by pressing the Charger Enable button (on the front panel of the RS3000) so it is no longer illuminated.
 - To maintain optimal performance in flooded batteries, an occasional equalize cycle may be required. See “Operating in Equalization Mode” on page 2–10.
 - While the batteries are being charged, you can monitor which stage they are in from the front panel of the RS3000 or from the System Control Panel.
- ◆ To operate the charger with the System Control Panel, refer to Chapter 3, “Configuration”.

Charger Operation with Battery Temperature Sensor

Since battery temperature is a key factor in correct charging, the charging formula must be adjusted (automatically and in real time) according to the actual battery temperature to ensure that batteries are fully charged, but not overcharged. For this reason, Xantrex has included a battery temperature sensor (see Figure 2-2) with your RS3000 Sine Wave Inverter/Charger and has temperature compensated the charge formula.

The battery temperature sensor continuously measures the temperature of the battery and adjusts charger output for a more accurate, temperature-compensated charge.

When batteries are cold, their chemical reaction is sluggish, meaning they don't absorb charge as easily. Thus a charge level optimized for room temperature will not charge the batteries sufficiently if they are cold. The charger must compensate by increasing its voltage to achieve the compensated equivalent of a room temperature charge. If the batteries are hot, the chemical reaction is hyperactive and they absorb energy too easily; thus a standard room-temperature charge would tend to overcharge a hot battery. Therefore, the charger compensates by reducing its voltage.

The battery temperature sensor automatically, and in real time, makes adjustments to the charger's voltage setpoints to properly charge your batteries. The actual charge compensation formula can be found on page A-3.

Important: It is normal to see a voltage that is different than the specified setpoint when charging if the battery case temperature is above or below 77 °F (25 °C)

If a battery temperature sensor is not present, the RS3000 uses the hot setting, the default value, unless the setting has been adjusted during configuration. Charging may not be effective at extreme temperatures. See "Charger Specifications" on page A-3.

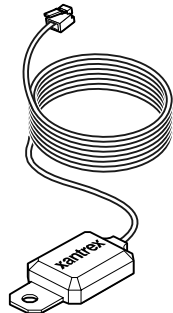

Figure 2-2 Battery Temperature Sensor

Operating in Equalization Mode



WARNING: Explosive gases

Equalization generates explosive gases. Ensure adequate ventilation.



CAUTION: Batteries may be damaged

Sealed lead-acid batteries and gel batteries must NEVER be equalized or premature battery failure will result. Equalize mode is disabled if you have selected “Gel” and “AGM” as the battery type.

Only flooded (wet) lead-acid batteries should be equalized. As a general rule, do not equalize a battery unless there are provisions to add water to it and the manufacturer recommends equalization.

If carried out too frequently or done improperly, equalization can damage your batteries. Never equalize a battery more than necessary. Always check electrolyte level before AND after equalization. Fill with distilled water per the battery manufacturer’s recommendation.



CAUTION: Risk of damage to DC load equipment

Equalization voltage may be as high as 15.8 volts DC. Disconnect sensitive loads from the battery before equalizing.

Follow the battery manufacturer’s recommendations for equalizing your batteries. As a guide, a heavily used flooded battery may need to be equalized once a month, and a battery in light service may only need to be equalized every two to four months.

Measure the specific gravity (S.G.) of each cell using a hydrometer. For fully charged lead-acid batteries, the reading should be approximately 1.265. Low specific gravity after charging or a 0.25 difference from cell to cell indicates the need for equalization.

Equalizing Batteries

Important: Equalization will be carried out after an absorption charge. Equalization only runs for 60 minutes and may need to be restarted if the specific gravity is still uneven.

To equalize your batteries:

1. Turn off or disconnect all loads on the battery.
The voltage applied to the battery during equalization may damage your electronic equipment. As well, equalization won't proceed correctly if loads are drawing current from the battery.
2. Check electrolyte level.
Fill with distilled water if the electrolyte level is low.
3. To request the equalization charge, ensure the Charger is enabled.
4. On the System Control Panel, select Equalize on the RS3000 home menu. For detailed information on configuring this setting, refer to "Equalize" on page 3-14.
5. When equalization is finished, check the battery electrolyte level. Top up as necessary with distilled water only and recheck the specific gravity as specified by the battery manufacturer.

Terminating the Equalization Process

The equalization process can be terminated in three ways:

- user cancellation from the System Control Panel, as shown in Figure 3-12 on page 3-16
- inverter/charger cancellation if AC is removed or the charger is disabled
- successful completion of the equalization process.

Operating Limits for Charger Operation

The maximum output current for the RS3000 is 150 amps. You can reduce the total output if you change the “Max Chg Rate” setting on the RS3000 Advanced Menu or the maximum “Power Share” setting on the RS3000 Basic Menu.

The charger can operate over an AC input range of 90–135 volts AC. This is the default setting and can be adjusted to 85–145 volts AC as a maximum range and to 110–120 volts AC as a minimum range. This wide range allows the RS3000 to charge your batteries even when incoming AC voltage is less than ideal.

Power Share

The RS3000 charger uses AC input line 1 to charge the batteries. The RS3000 charger shares incoming power with AC loads on line 1 only. The AC loads have priority, which means that the charger will reduce its output with large AC loads and increase the output again when the AC load decreases. The regulatory maximum for continuous AC loads is 80% of the breaker rating that the loads are connected to.

The RS3000 senses pass-through current going to the AC load. The difference between the pass-through (load) and 80% of the Power Share setting is the current that is available for charging the batteries.

For example, if the AC input of the RS3000 is from an AC panel with a 30A breaker, the Power Share setting on the System Control Panel should be selected as 30A. Based on this, the charger will control the charge current so that the total current draw is equal to or less than 24A in this case. Should the load current be more than about 24A, the charger output will reduce to 0A, but the RS3000 will continue to supply the loads. The RS3000 will continue to pass-through power to the loads, even if the load current exceeds the Power Share setting. In this case, it will be up to the user to remove/disconnect loads if tripping the AC input breaker supplying the RS3000 is to be avoided.

Monitoring the RS3000 Indicator Lights

The ten indicator lights on the front panel show you the operating status of the RS3000. A description of the lights is provided in Table 2-2.

If none of the front panel lights are on, see “Troubleshooting Reference” on page 4-4.

Table 2-2 Front Panel Lights

Light Illuminated	Color	Status	Action or Status Item
External AC	Green	When the RS3000 is connected to a qualified AC source or a generator, the External AC light illuminates.	You can run your appliances from an AC source like the utility grid or a generator.
Inverter ON	Green	When the RS3000 is enabled (on) and producing AC or load sensing, the Inverter ON light illuminates. This light is not illuminated if the unit is charging.	You can run your appliances from the inverter.
Low Battery	Yellow	When the Low Battery light illuminates, the battery level is low.	You can run your appliances but your battery level is low. Charge your battery or connect to an AC source or turn off the inverter.
Network	Green	Indicates that there is activity on the network.	Communication on the network
Fault	Red	A fault has occurred on the network.	Investigate and clear the fault condition.
Charger ON	Green	When the RS3000 is in charge mode, the Charger ON light is illuminated. In three-stage charging, charging occurs in 3 stages: bulk, absorption, and float. One of these 3 lights will be illuminated at the same time the Charger ON light is illuminated. If the Charger ON light is off, the RS3000 is not in any charge mode.	The charger is active and charging your batteries. The Charger ON light is always illuminated if charging, whether the unit is putting out current or not.

Table 2-2 Front Panel Lights

Light Illuminated	Color	Status	Action or Status Item
Bulk	Green	RS3000 is in bulk mode of battery charging.	These lights indicate which state of charge the RS3000 is in.
Absorption	Green	RS3000 is in absorption mode of battery charging.	
Float	Green	RS3000 is in float mode of battery charging. The Float light illuminates in three-stage charging.	
Equalize	Yellow	RS3000 is in equalize mode of battery charging.	

Faults and Warnings

A fault affects the operation of the unit. A manual fault requires user intervention by clearing the condition and then pressing the Reset button on the inverter/charger’s front panel. See the *System Control Panel Owner’s Guide* for information on clearing faults from the System Control Panel.

A warning alerts you to a condition that could possibly affect operation of the unit.

See “Faults and Warnings” on page 4–2 for more explanation on the difference between faults and warnings.

Monitoring Status Messages on the System Control Panel

Refer to “System Menu Map” on page 3–3 of the Configuration chapter.

System Modes

This section provides an overview of the four different system modes.

The system modes described in this section affect the performance and behavior of the RS3000 and all other Xanbus-enabled devices on the Xanbus system. You'll have to change the system mode when travelling, putting your vehicle in storage, or when installing a Xanbus-enabled device.

You can change system modes using the System Settings menu on the System Control Panel.

You can also use the red System button on the System Control Panel to put the System Control Panel and all other Xanbus-enabled devices into Power Save mode only.

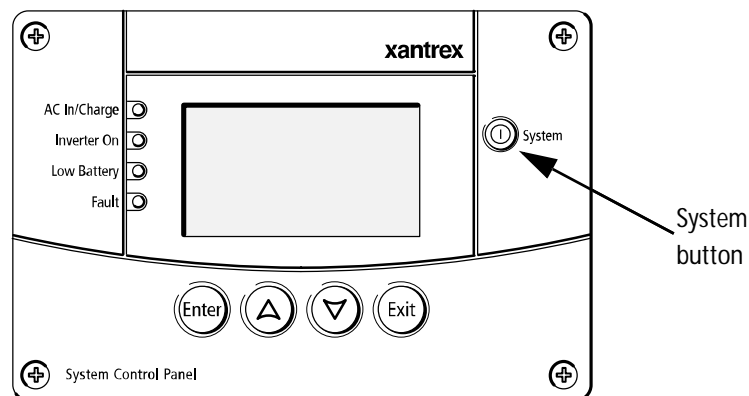

Figure 2-3 System Control Panel

System modes are changed using the System Settings menu. The four system modes are:

- Operating
- Power Save
- Safe
- Hibernate

Please read the section about each system mode to find out which mode is appropriate for different conditions or situations.

Operating Mode

Characteristics In Operating mode, all communications are enabled on the Xanbus system. All power conversion functions are enabled. Each Xanbus-enabled device is monitoring and communicating its input.

The basic state of the System Control Panel is Operating mode. In Operating mode, the System Control Panel communicates with other Xanbus-enabled devices and displays all the network information which it is configured to display.

Whenever the System Control Panel or any other device on the Xanbus system is powered on or reset, it will be in Operating mode.

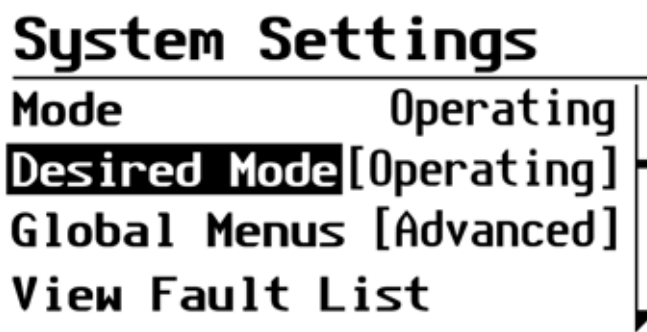

Figure 2-4 Operating Mode

Power Save Mode

Characteristics Power Save mode minimizes power draw by the System Control Panel and other Xanbus-enabled devices on the Xanbus system. Power Save mode stops all communication on the network and disables the power conversion functions of Xanbus devices. For example, in Power Save mode, the inverter/charger will not invert and an Automatic Generator Start will not start a generator.

When to use Use Power Save mode during periods when your power needs are minimal—while you are driving, for example. Putting the system in Power Save mode will help preserve the charge in your batteries during periods of minimal power usage.

Entering and exiting Power Save mode also serves as a “reset” command for the system.

If there are active faults in the system, you cannot put the system into Power Save mode. Clear any active fault, correct the condition that caused the fault, then put the system into Power Save mode.

To enter or exit Power Save mode:

- ◆ Press and hold the System button on the System Control Panel for one second.

After you release the System button, the System Control Panel screen and indicator lights will turn off.

You can also enter or exit Power Save mode on the System Settings menu by selecting Desired Mode and scrolling to PowerSave as shown in Figure 2-5.

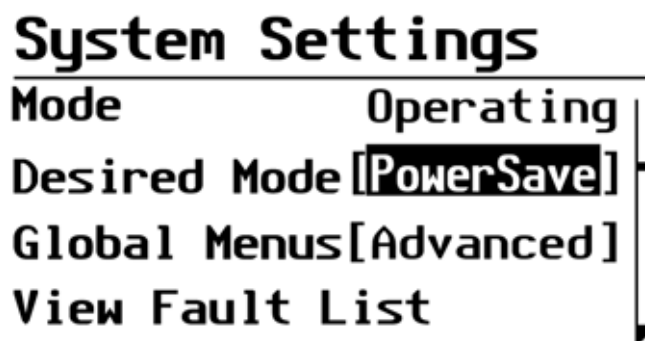

Figure 2-5 Power Save Mode

Returning to
Operating mode

If an inverter/charger supplies power to the network, applying AC input with utility power or generator power automatically returns the system to Operating mode.

Safe Mode



CAUTION: Unexpected behavior

Before installing or removing a device on the network, put the network into Safe mode. Putting the network into safe mode prevents unexpected behavior.

Characteristics

Selecting Safe mode stops the generator (if it is running) and puts the System Control Panel (and all Xanbus-enabled devices) into Safe mode. While in Safe mode, the System Control Panel remains powered, “listening” to and reporting its status to the network. However, the output power of all Xanbus-enabled devices is disabled and all inverting, charging, and generator starting activity stops. In Safe mode, the RS3000 will not transfer AC power from a source.

	<p>In Safe mode, the RS3000 continues to communicate, but the inverting and charging functions are disabled.</p>
When to use	<p>Use Safe mode when you are adding or removing devices from the network. Authorized service personnel must also put the System Control Panel in Safe mode before performing software upgrades and diagnostics with the Xantrex Diagnostic Tool.</p> <p>If the System Control Panel is powered off while in Safe mode, it will be in Safe mode when it is powered up again.</p> <p>To return to Operating mode:</p> <ul style="list-style-type: none">◆ On the System Settings menu, under Desired Mode, select “Operating.”

Putting the System into Safe Mode

When you are installing or removing devices from the Xanbus system, putting the system into Safe mode prevents unexpected behavior.

To enter Safe mode:

1. On the Select Device menu, use the down arrow button to highlight System.

The cursor on the right of the screen indicates where you are in the menu.

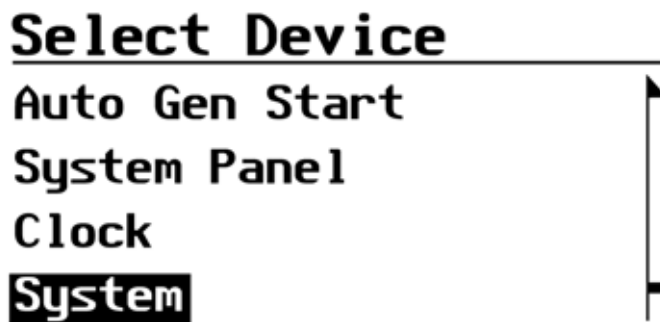

Figure 2-6 Select Device Menu

2. Press Enter.
The System Settings menu appears.

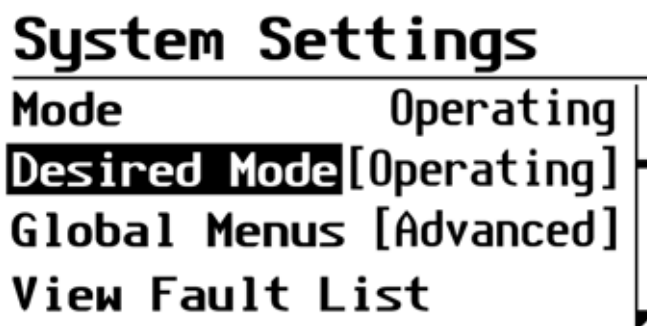

Figure 2-7 System Settings Menu

3. On the System Settings menu, with Desired Mode highlighted, press Enter.
4. Use the down arrow button to scroll through the other modes to select Safe mode.

For more information on the different system modes: Operating, Power Save, and Hibernate see “Operating in Invert Mode” on page 2–6.

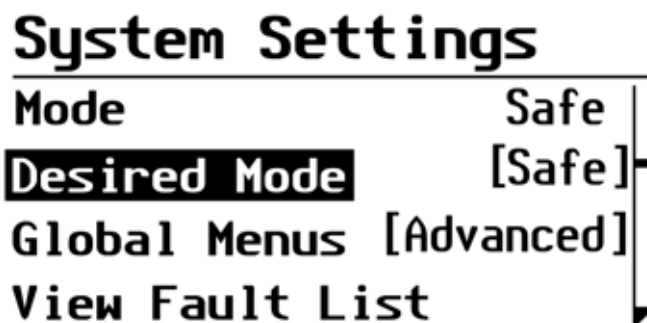

Figure 2-8 Safe Mode

5. Press Enter.
You are now in Safe mode.
6. Press Exit twice to return to the System Home Screen.

To exit Safe mode and return to Operating mode:

1. On the System Settings menu, under Desired Mode, select “Operating.”
2. Press Enter.

Hibernate Mode

Characteristics Hibernate mode removes network power from the System Control Panel and all Xanbus-enabled devices on the Xanbus system. The System Control Panel suspends all operations (including starting and stopping the generator) until power is restored to the network. All Xanbus-enabled devices other than the RS3000 have no network power.

When to use Use Hibernate mode when the Xanbus system is left unattended for long-periods of time to prevent any unattended system activity and to prevent battery drain during long periods of inactivity.

The system will automatically enter Hibernate mode if it is in Power Save mode for more than two hours.

Important: To prevent any unattended system activity, put the system into Hibernate mode from the System Control Panel before putting your RV or boat into storage.

If there are active faults in the system, you cannot force the system into Hibernate mode. Clear any active faults, correct the condition that caused the fault, then put the system into Hibernate mode.

Restoring power Once in Hibernate mode, the System Control Panel cannot return the System to Operating mode. You must restore power to the network by pressing the Reset button on the RS3000 front panel for several seconds. When the RS3000 has been reset, all of the front panel lights illuminate and remain on for a minimum of five seconds. After five seconds, the lights remain illuminated until the front panel has status information for all the lights.

If an inverter/charger supplies power to the network, you can bring the system out of Hibernate mode either by pressing the reset button on the inverter/charger front panel or by applying AC input with utility power or generator power.

3

Configuration

Chapter 3, “Configuration” contains information about all configurable settings and procedures for the RS3000.

This chapter provides information on using the SCP to configure the RS3000 settings. Please refer to the *System Control Panel Owner’s Guide* for detailed information on how to use the SCP.

General Configuration Information

System Control Panel

The System Control Panel provides configuration and monitoring capability for all Xanbus-enabled devices on the network. All changes to the configuration of the RS3000 are made with the System Control Panel (SCP). See “Using the System Control Panel” on page 2–3.

The front panel of the RS3000 provides limited control, including reset; charger enable and disable; and inverter enable and disable.

Enabling a function When a function is enabled, it is allowed to occur but other conditions may have to be met before the function is activated or turned on. For example, the charger function on the RS3000 may be enabled, but it will not charge unless qualified AC power is present.

Disabling a function When a function is disabled, it is not allowed to occur and if it is occurring, it is terminated. Regardless of other conditions, the function will not be activated. For example, even if AC power is present, if the charger is disabled, the unit will not charge.

These functions can also be controlled from the System Control Panel.

System Menu Map

Figure 3-1 provides a map of how the System Control Panel screens and menus are organized. The order of devices appearing on the System Control Panel will vary, depending on the order in which they've been connected to the network.

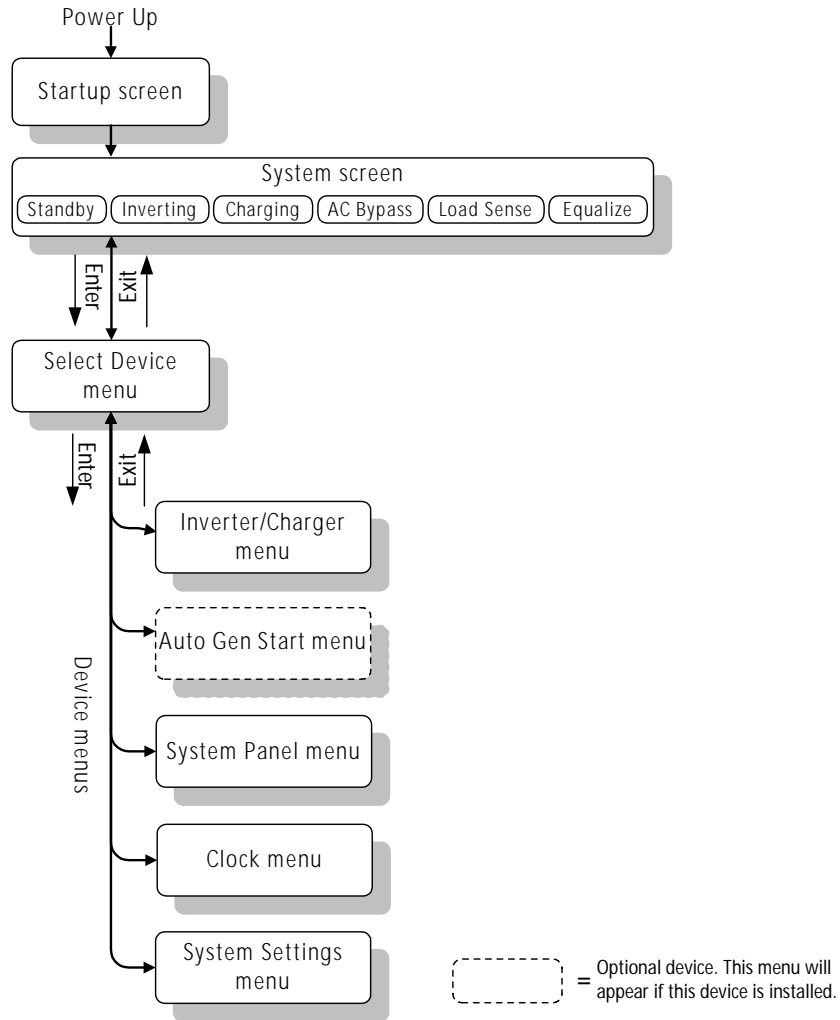

Figure 3-1 System Menu Map

Viewing the System Screen

The System screen displays system activity. The information appearing on the System screen varies with the status of the inverter/charger: Standby, Inverting, Charging, AC Bypass, Load Sense or Equalize. See “Modes” on page 3–10 for an explanation of the different modes. For example, Figure 3-2 shows the RS3000 in the float stage of charging.

You cannot select or change any of the information on the System screen. If you would like to view more detailed information, press the Enter button (indicated by the menu arrow) to go to the Select Device menu.

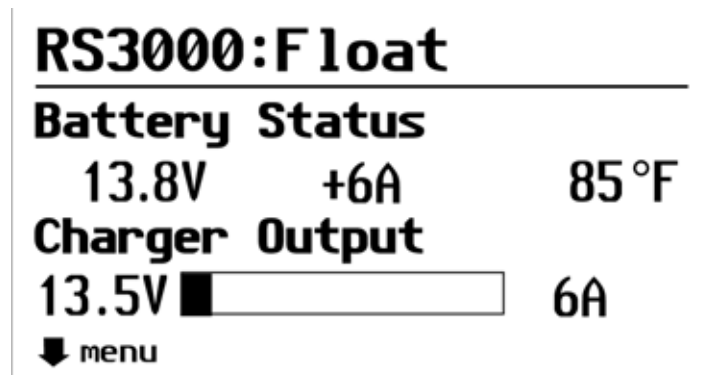

Figure 3-2 RS3000 Float System Screen (Example)

Viewing the Select Device Menu

The Select Device menu is where you can view a list of all the Xanbus-enabled devices in your power system.

To view the Select Device menu:

- ◆ On the System screen, press Enter.

The Select Device menu appears with RS3000 highlighted, as shown in Figure 3-3.

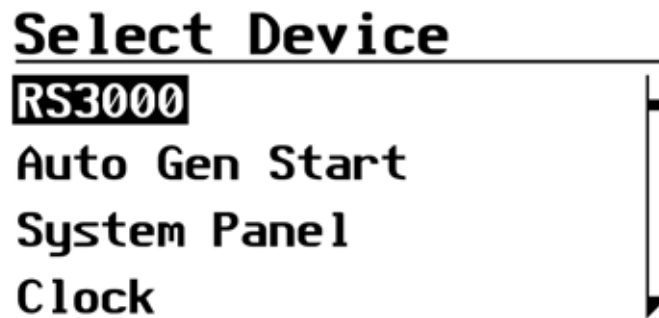

Figure 3-3 Select Device Menu

Selecting the RS3000 from the Select Device Menu

To select the **RS3000** from the **Select Device** menu:

1. With RS3000 highlighted, press Enter.
The RS3000 menu appears, as shown in Figure 3-4.

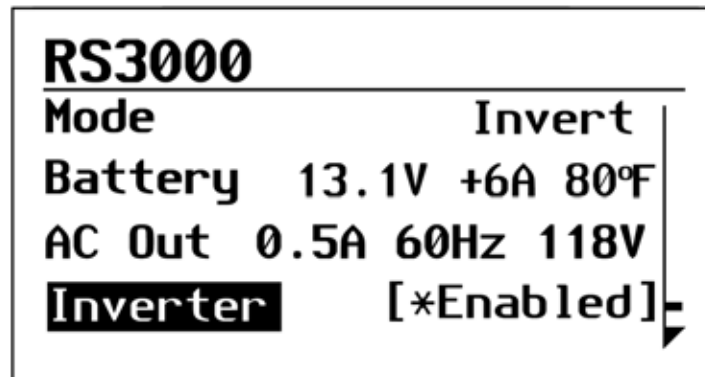

Figure 3-4 RS3000 Menu in Invert Mode

You can view and change RS3000 settings from the device menu. The number of settings on the RS3000 menu will depend on whether you have selected to view basic or advanced menus.

Selecting the RS3000 Basic Menu

RS3000 basic menu lists status information and settings you may have to adjust on a routine basis. It provides access to basic control of the inverter/charger.

Selecting the RS3000 Advanced Menu

RS3000 advanced menu lists status information and settings which require that you understand and plan for the changes you make. You may not have to adjust these settings as part of regular operation.

The System Control Panel shows the RS3000 basic menu by default. If you would like to view the advanced menu, you must go to the System menu and select Global Menus.

Important: When you set Global Menus to Advanced, the System Control Panel will display the advanced menus for all devices. To return to viewing the basic menu for any Xanbus-enabled devices, select Basic Menu from the advanced menu for that device.

To select the RS3000 Advanced Menu:

1. On the Select Device menu with System highlighted, as shown in Figure 3-5, press Enter.

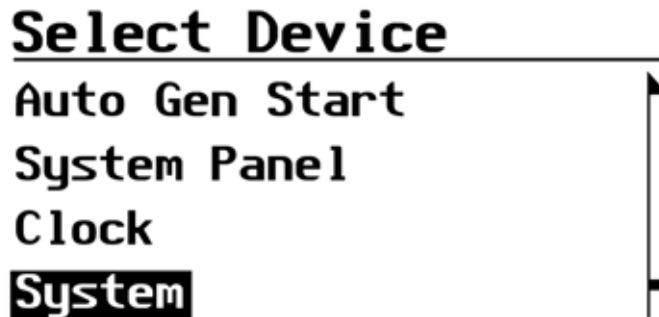

Figure 3-5 Highlighting System on the Select Device Menu

2. Scroll with the down arrow button to highlight Global Menus.

```
System Settings
-----
Mode                Operating
Desired Mode [Operating]
Global Menu [Advanced]
View Fault List
```

A screenshot of a terminal-style menu titled "System Settings". The menu items are "Mode", "Desired Mode [Operating]", "Global Menu [Advanced]", and "View Fault List". The "Global Menu" option is highlighted with a black background. A vertical cursor is on the right side of the menu, pointing to the "Global Menu" option.

Figure 3-6 Highlighting Global Menu

3. Press Enter.
4. Select Advanced and press Enter.
5. Press Exit to return to Select Device menu.

Returning to RS3000 Basic Menu

You can return to viewing the RS3000 basic menu by selecting Basic Menu from the RS3000 advanced menu, as shown in Figure 3-7. Advanced menu items will no longer be visible on the System Control Panel.

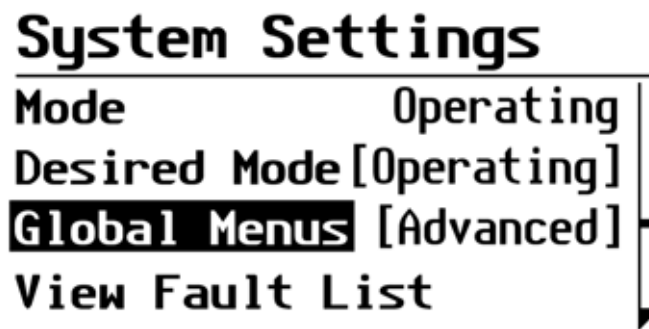
```
RS3000
-----
Load Sense          [Off]
Clear Faults
View Device Info
Basic Menu
```

A screenshot of a terminal-style menu titled "RS3000". The menu items are "Load Sense [Off]", "Clear Faults", "View Device Info", and "Basic Menu". The "Basic Menu" option is highlighted with a black background. A vertical cursor is on the right side of the menu, pointing to the "Basic Menu" option.

Figure 3-7 Returning to RS3000 Basic Menu

Selecting and Adjusting the Configurable Settings

You can view or change RS3000 settings from the RS3000 menu. Status information is not configurable. Configurable settings are indicated by square brackets [] and can be adjusted.

Follow these steps to change any RS3000 setting.

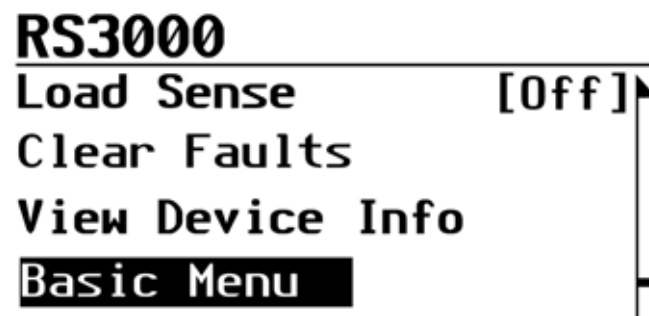
1. On the RS3000 menu, use the up arrow or down arrow button to highlight the setting you want to change.
2. Press Enter to highlight the value of that Configurable setting, indicated by square brackets [].

The previously set value appears with an asterisk beside it, as shown in Figure 3-4.

3. Use the up arrow or down arrow button to change the value. Holding down a button lets you scroll through values quickly.
4. Press Enter to select the value.
5. If you have another setting to change, return to step 1.

Or

If you have no more settings to change, press Exit to return to the Select Device menu.

Selecting the Default Settings

All configurable items on the RS3000 menu items have a default setting. The default setting is the value which was set at the time the unit was originally installed.

You can restore individual settings to their default value or you can restore all values to default settings. See “Restore Defaults Warning” on page 3-29.

RS3000 Menu Structure

An overview of the RS3000 menu structure is shown in Figure 3-8. The System Control Panel displays the RS3000 basic menu and advanced menu.

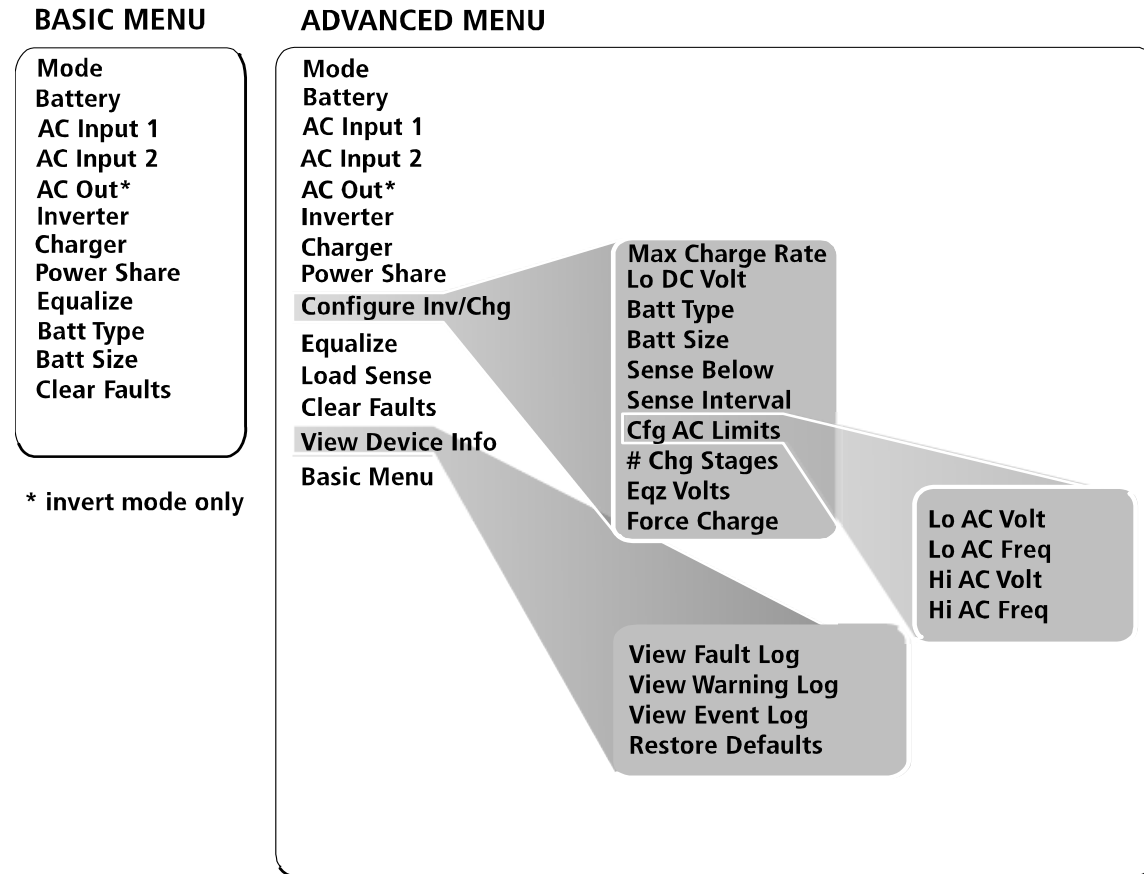

Figure 3-8 RS3000 Menu Structure — Overview

RS3000 Device Menu

The RS3000 device menu displays status information on the different modes of the inverter/charger. The first three or four lines of the device screen displays dynamic content that changes, depending on what mode that the RS3000 is in.

Modes

The first line on the device menu indicates which mode that the RS3000 is in. Table 3-1 defines the seven different modes: Invert, Bulk, Absorption, Float, AC Bypass (AC Passthru), Load Sense, and Equalize.

Table 3-1 Modes

Mode	Description
Invert	The RS3000 is converting DC power to AC power.
Bulk	The first stage of three-stage battery charging. Current is supplied to the batteries at a constant rate while voltage gradually rises.
Absorption	The second stage of three-stage battery charging. Voltage remains constant and current reduces as the battery becomes charged. This ensures complete charging.
Float	The third stage of three-stage battery charging. After the batteries reach full charge, charging voltage is reduced to a lower level to prevent gassing and to prolong battery life. This stage is often referred to as a maintenance charge. Rather than charging a battery, it keeps an already-charged battery from discharging while providing load current.
AC Bypass (ACPassthru)	AC input from an AC source like the utility grid or from a generator is allowed to pass through the unit to operate connected AC loads. The charger is not enabled but AC is qualified as good and passed through the unit.
Load Sense	In order to minimize power draw from the battery, the inverter will periodically check if a load is connected when the inverter is enabled.
Equalize	To improve the life and performance of a non-sealed, flooded (or wet) battery, the RS3000's multi-stage charging cycle includes a manual equalize mode that can be used if recommended by the battery manufacturer.

Battery

The second line of the device screen indicates the status of the battery. This line displays the volts (V); current (A) as either (+) positive amps (indicating that the battery is charging) or (–) negative amps (indicating the battery is discharging because you're inverting); and battery temperature in either °F or °C.

AC Input1 and AC Input2

When the RS3000 has external AC input connected, these AC display lines indicate the status of the AC input. Each AC display line shows the values for current (A), frequency (Hz), and the AC voltage in (V).

AC Out

This line is displayed only when the RS3000 is in invert mode. This line indicates the AC output and shows the values for current (A), the frequency (Hz), and the AC voltage in (V).

RS3000 Menu (Basic)

The RS3000 basic menu indicates the status of items and lists settings that you may have to adjust on a routine basis.

If advanced menu is enabled, scroll through the RS3000 advanced menu items until Basic Menu is highlighted and press Enter. See “Returning to RS3000 Basic Menu” on page 3–7.

This section describes each item in detail with an example of the line item as it appears on the System Control Panel. Each item is described in terms of its purpose, whether it is a display or configurable setting, when to use, and the outcome of changing the setting.

Important: On the System Control Panel, use the up arrow button or down arrow button to change the value. Holding down a button lets you scroll through values quickly.

Inverter

Configurable setting This setting lets you enable or disable the inverter. In the example shown, the inverter is enabled. For an explanation of enable and disable, see “Terminology” on page C–1. The default setting for the inverter is disabled.

Inverter	[Enabled]
----------	-----------

When to use Enable the inverter when you would like to have AC power from the inverter.

Outcome The inverter is enabled. The inverter provides power from the batteries unless qualified AC input power is present.

Charger

Configurable setting This setting lets you enable or disable the operation of the charger. In the example shown, the charger is enabled. The default setting for the charger is enabled.

Charger	[Enabled]
---------	-----------

When to use Set the charger to Enabled when you want your batteries charged when connected to AC power.

The charger can be set to Disabled anytime during the charge cycle to immediately stop charging. The charger can also be enabled or disabled from the RS3000 front panel.

Outcome If the AC is qualified, the charger operates. If the AC is not qualified, then the charger will not operate until AC qualifies.
See “Force Charge” on page 3–23 for information on automatic charging.

Power Share

Configurable setting Power Share is a configurable setting that you set to match to the breaker rating on the AC input. This setting is used to ensure that the charger limits its output to try to prevent nuisance tripping of the AC input breaker due to the total current drawn by the charger and your other AC loads. For more information on this feature, see “Power Share” on page 2–12.

In the example shown, Power Share is set to 30A.

Power Share	[30A]
-------------	-------

You can adjust the power share settings as follows:

Range of values	Increment	Default
5 to 50 amps	5 amps	30 amps

When to use Set the Power Share setting to match the AC input breaker. Use this setting when connecting to an AC source. If using multiple AC sources via an AC transfer switch, adjust this setting to the smaller AC breaker size.

Outcome Setting the value higher than the AC source’s external breaker could cause the external breaker to trip.

Equalize

Configurable setting This setting lets you enable or disable charger equalization, if the battery type is flooded (or wet). Equalization can be turned on (enabled) or off (disabled). The default setting for equalize is Off.

Equal i ze	[Off]
------------	-------

When to use Review the section, “Operating in Equalization Mode” on page 2–10 before adjusting this setting. This menu item is displayed if the battery type allows equalization.

In the RS3000 home menu, highlight Equalize, as shown in Figure 3-9.

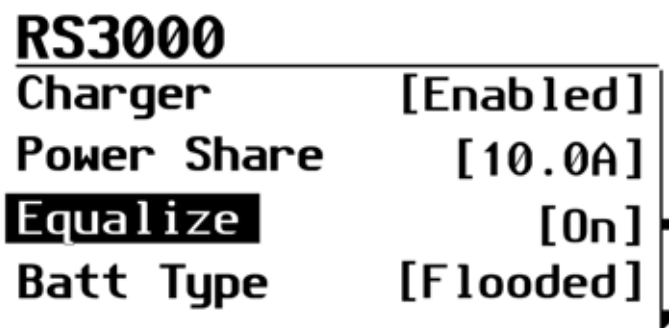

Figure 3-9 Equalize On

When you select On, the equalization confirmation warning appears, as shown in Figure 3-10.

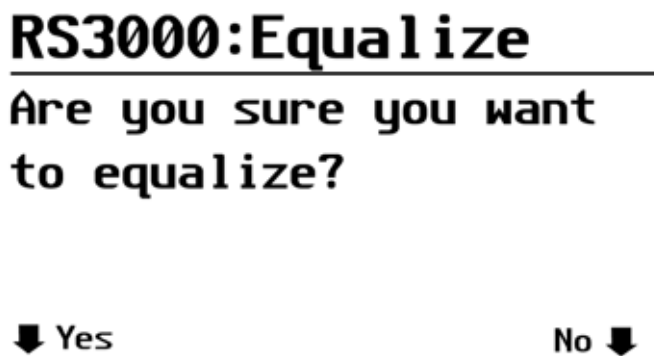

Figure 3-10 Equalize Confirmation Warning

RS3000:Equalize

Are you sure you want to cancel Equalization?

⬇ Yes

No ⬇

Figure 3-12 Equalization Cancellation Warning

If you choose Yes, the equalization process is cancelled and you are returned to the RS3000 home menu.

If you choose No, the equalization home screen as shown in Figure 3-11 appears.

Batt Type

Full name

Battery Type

Configurable setting

Select the type of battery from flooded, custom, AGM, or gel. If a battery temperature sensor is not present, the RS3000 uses the hot setting which is the default value, unless the setting has been adjusted during configuration.

Batt Type	[Flooded]
-----------	-----------

When to use

This setting is adjusted for the type of battery you have. It is important during installation to choose the correct setting (battery type) to optimize the charge algorithm for your battery and to properly enable or disable equalization. See “Battery Charging Reference” on page B-1 for more information.

The custom setting is selected to get the battery settings programmed by the dealer.

Batt Size

Full name Battery size
Configurable setting This features let you select the size of the battery bank being charged.

Batt Size	[440 Ah]
-----------	----------

You can adjust the Battery Size settings as follows:

Range of values	Increment	Default
50 Ah to 2000 Ah	10 Ah	440 Ah

When to use Adjust this setting to your actual battery bank size.
Outcome Reduces the maximum charger current to protect against charging smaller batteries too aggressively. This setting charges batteries appropriately based on capacity. (See the Battery Information section in the *RS3000 Sine Wave Inverter/Charger Installation Guide* for more information.)

Clear Faults

Purpose Clear Faults is a command which clears all active faults in the RS3000. When faults are cleared, the device will resume normal operation. If the fault condition still exists, the fault will reoccur. See “Fault Types” on page 4–2 for an explanation of faults.

Clear Faults

You can adjust the Clear Faults settings as follows:

Value	Effect
Yes	Faults are cleared
No	No action

RS3000 Menu (Advanced)

The advanced menu lists settings that provide you with additional control over RS3000. However, you may not have to adjust these settings as part of regular operation. For a listing of advanced menu items, see “RS3000 Menu Structure — Overview” on page 3–9.

In addition to several items from the basic menu, the RS3000 advanced menu contains the following sub-menus and commands:

- Configure Inv/Chg (Configure Inverter/Charger)
- View Device Info

When you select a sub-menu and press Enter, a list of menu items appears.

These settings are only visible if Advanced Menu is selected. To select the RS3000 Advanced Menu, see “Selecting the RS3000 Advanced Menu” on page 3–6.

This section describes the menu items in detail. Each item is described as a display or configurable setting, when to use the setting, and the outcome of changing a setting.

Inverter

This feature is the same as described on the basic menu on page 3–12.

Charger

This feature is the same as described on the basic menu on page 3–12.

Power Share

This feature is the same as described on the basic menu on page 3–13.

Configure Inv/Chg (Configure Inverter/Charger)

Cfg Inv/Chg is a sub menu command. If you select this item, you’ll access a list of sub-menu items. See “Configure Inv/Chg Menu (Configure Inverter/Charger Menu)” on page 3–20.

Equalize

This feature is the same as described on the basic menu on page 3–13.

Load Sense

Configurable setting This setting lets you enable (turn On) or disable (turn Off) the load sensing function. The default setting for this value is Off, as shown in the example.

Load sense	[Off]
------------	-------

When to use Enable this setting if you want the inverter to conserve battery power when there are small loads or no loads applied.

Outcome A small load like a clock display on a microwave may not get power. When loads are below the load sense threshold, the inverter will turn off the output to save battery power.

Clear Faults

This feature is the same as described on the basic menu on page 3–17.

View Device Info

For more information on this sub menu, Device Information, see “View Device Info (View Device Information)” on page 3–27.

Basic Menu

Purpose Selecting Basic Menu takes you back to the basic menu of the RS3000 only. Advanced menu items will no longer be visible on the System Control Panel.

When to use Use this setting when you want to return to the basic menu of the RS3000.

Sub-Menus

Configure Inv/Chg Menu (Configure Inverter/Charger Menu)

Cfg/Inv Chg is a sub-menu. If selected, the following list of sub-menu items appears.

Max Chg Rate

Full name Maximum charge rate

Configurable setting The actual battery charge rate is determined by two things: the battery bank size setting (C) divided by 5 ($C \div 5$) and the charge rate setting (0 to 100%).

For example, if the battery bank size is set to 300 Ah (C) and the charge rate is set at 100%, the maximum charge rate is:

$$300 \div 5 = 60 \text{ amps} \times 100\% \text{ which is a 60 amp charge rate.}$$

If the charge rate setting is adjusted to 50%, the maximum charge rate is:

$$300 \div 5 = 60 \text{ amps} \times 50\% \text{ which is a 30 amp charge rate.}$$

The RS3000 has a maximum charge rate of 150 amps. Even though you can set a bank size of 2000 Ah, where $C \div 5$ is $2000 \div 5 = 400$ amps, the RS3000 would still charge at 150 amp maximum.

Max Chg Rate	[100%]
--------------	--------

You can adjust the Max Chg Rate settings as follows:

Range of values	Increment	Default
10% to 100%	10	100%

When to use

Displayed only if in charger mode when you wish to control the maximum charge rate to your batteries.

Lo DC Volt

Full name Low DC input voltage shutdown
 Configurable setting This setting lets you set the low voltage shutdown level for the inverter.

Lo DC Volt	[10.0V]
------------	---------

You can adjust the Lo DC Volt settings as follows:

Range	Increment	Default
10 to 12 volts	0.1 volt	10 volts

When to use This setting limits the depth of discharge on your battery.

Batt Type

This feature is the same as described on the basic menu on page 3–16.

Batt Size

This feature is the same as described on the basic menu on page 3–17.

Sense Below

Configurable setting This setting lets you adjust the load power at which the inverter will turn on. This setting saves battery consumption by keeping the inverter disabled (turned off) except when load demand is present.

Sense Below	[50W]
-------------	-------

You can adjust the Sense Below settings as follows:

Range of values	Increment	Default
40 watts to 150 watts	10 watts	50 watts

When to use Adjust this setting to control the inverter based on the load.

Outcome Sets the load threshold at a power level where you want the inverter to stay on, for example, when a sufficient load is applied. For more information on this feature, see “Load Sense Mode” on page 2–6.

Sense Interval

Configurable setting This setting lets you adjust the interval between load sense pulses. The longer the interval, the more power you will save. However, the longer intervals may cause delays in the inverter powering up and starting your loads. For more information on this feature, see “Load Sense Mode” on page 2–6.

Sense Interval [1s]

You can adjust Sense Interval settings as follows:

Range of values	Increment	Default
1 to 25 seconds	1 second	1 second

Cfg AC Limits (Configure AC Limits)

Cfg AC Limits is a sub-menu. If selected, a list of sub-menu items appear. For more information on this sub menu, Configure AC Limits, see page 3–24.

Chg Stages

Full name Number of charge stages

Configurable setting These settings let you adjust your charger stages to either two-stage charging or three-stage charging. The default setting for # Chg Stages is 3Stage. (See “Battery Charging Reference” on page B–1 for an explanation of two-stage and three-stage charging.)

Chg Stages [3Stage]

Eqz Volts

Full name Equalization voltage

Configurable setting This setting lets you set the desired equalization voltage. This menu is displayed only if charger equalization is enabled. Select a setting based on the battery manufacturer’s recommendation. For more information, see “Battery Charging Reference” on page B–1.

Eqz Volts	[15.5V]
-----------	---------

You can adjust Eqz Volts settings as follows:

Range of values	Increment	Default
13.5 to 15.5 VDC	0.1 volts	15.5 VDC

Force Charge

Configurable setting This setting forces the charger to be enabled (On) whenever you have requalified AC. The default setting for Force Charge is On (enabled).

Force Charge	[On]
--------------	------

When to use Turn Force Charge to On if you want to automatically start charging whenever you connect to a qualified AC input, regardless of whether the Charger is Enabled or Disabled.

Turn Force Charge to Off if you want charging to be determined only by whether the Charger is Enabled or Disabled.

Outcome If Force Charge is turned to On, the charger starts whenever you have qualified AC.

Cfg AC Limits (Configure AC Limits)



CAUTION: Risk of damage to equipment

The following configuration settings adjust the quality of the AC input source that the inverter/charger will qualify and pass through to your AC loads. Voltage or frequency that is too high or too low for a particular piece of load equipment may cause damage to that load.

Before adjusting these settings, refer to the electrical rating of connected load equipment. Most equipment that is marked with a single voltage (120 VAC, for example) rather than a range (110–125 VAC) can be expected to run properly over the range of 108 VAC to 125 VAC, since this is the normal supply range of electrical utilities.

Lo AC Volt

Full name Low AC Transfer voltage (AC under voltage level)

Configurable setting Low AC Transfer voltage is the voltage below which the inverter/charger no longer qualifies AC as “good”, opens the relay, and attempts to transfer to Invert mode if Invert is enabled.

Lo AC Volt	[90.0V]
------------	---------

You can adjust Lo AC Volt settings as follows:

Range of values	Increment	Default
85 to 110 VAC	1 volt	90 VAC

When to use This setting lets you adjust the AC parameters when AC supply is outside of the lower voltage range required for electrical equipment.

Outcome The lower level of voltage that will be accepted as “good” by the inverter/charger can be varied.

Lo AC Freq

Full name Low AC transfer frequency (AC under frequency level)
Configurable setting This setting lets you adjust the lowest frequency at which the inverter/charger no longer qualifies AC as “good” and attempts to transfer to invert mode.

Lo AC Freq	[55Hz]
------------	--------

You can adjust Lo AC Freq settings as follows:

Range of values	Increment	Default
55 to 58 Hz	1 Hz	55 Hz

When to use This setting can be used when the AC supply frequency is lower than the set value required for the electrical equipment.

Outcome The lower frequency of the AC supply above which it will be qualified as “good” by the inverter/charger can be varied.

Hi AC Volt

Full name High AC transfer voltage (AC over voltage level)
Configurable setting This setting lets you adjust the voltage above which the inverter/charger no longer qualifies AC as “good” and transfers to Invert.

Hi AC Volt	[135V]
------------	--------

You can adjust Hi AC Volt settings as follows:

Range of values	Increment	Default
120 to 145 VAC	1 volt	135 VAC

When to use This setting lets you adjust the AC parameters when AC supply is outside the upper voltage range required for electrical equipment.

Outcome The upper limit of the voltage that will be qualified as “good” by the inverter/charger can be varied.

Hi AC Freq

Full name High AC transfer frequency (AC over frequency level)
Configurable setting This setting lets you adjust the highest frequency at which the RS3000 no longer qualifies AC as “good” and transfers to Invert.

Hi AC Freq	[65Hz]
------------	--------

You can adjust Hi AC Freq settings as follows:

Range of values	Increment	Default
62 to 70 Hz	1 Hz	65 Hz

When to use This setting lets you adjust the AC parameters when the AC supply is outside the higher frequency range required for electrical equipment.

Outcome The highest frequency of the AC supply that will be qualified as “good” by the inverter/charger can be varied.

View Device Info (View Device Information)

If you select the View Device Info, the RS3000 Device Info menu appears, as shown in Figure 3-13, and allows you to view the Fault, Warning and Event logs and restore the default setting for the RS3000.

On the menu, the scroll bar (the black rectangular shape on the right) moves vertically as you scroll through the list, indicating where you are on the menu.

RS3000:Device Info

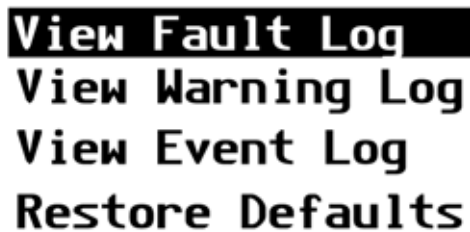

View Fault Log
View Warning Log
View Event Log
Restore Defaults

Figure 3-13 RS3000 Device Info Menu

For an explanation of faults and warnings, see “Faults and Warnings” on page 4–2. An event is an indicator of which of the system modes that the unit has been in.

View Fault Log

The Fault log displays the 20 most recent faults for your reference. The Fault log is similar to the Event log shown in Figure 3-14.

View Warning Log

The Warning log displays the 10 most recent warning. The Warning log is similar to the Event log shown in Figure 3-14.

View Event Log

Display setting The Event log, shown in Figure 3-14, displays the 10 most recent events. Events can include:

- Changing the system mode
- Enabling or disabling the charger

Important: The Move Down arrow on the right of the menu indicates additional menu items below the bottom edge of the display.

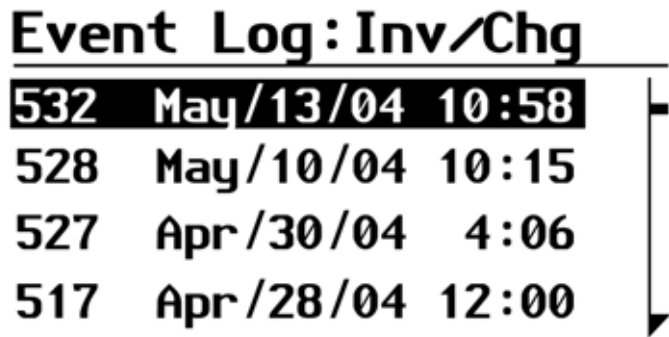
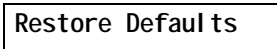

Figure 3-14 Event Log

When to use The list provides useful information to a technical user about events on the system, including an event ID, and the date and time of the event.

Restore Defaults

Configurable setting The Restore Default command restores the default settings for each device.



When to use Adjust this setting when you wish to restore your settings to defaults.

Important: Restoring to defaults will overwrite all of the stored values.

When you select Restore Defaults, a warning message appears, as shown in Figure 3-15:

Warning: W252
RS3000
Please confirm:
Restore device's
default settings.
↓ continue cancel ↓

Figure 3-15 Restore Defaults Warning

If you select continue, your settings will be restored to default.

If you select cancel, your existing settings will be retained and the Device Info menu appears.

4

Troubleshooting



WARNING: Electrical shock and fire hazard

Do not disassemble the RS3000. It does not contain any user serviceable parts. Attempting to service the unit yourself could result in electrical shock or fire.

The RS3000 is designed for high reliability of operation and has a number of protection features to provide trouble free operation. If, however, you have any problems operating your inverter/charger read this troubleshooting chapter.

If you cannot resolve the problem, record the necessary information on the form, “Information About Your System” on page WA-4. This information will help your dealer or Xantrex Customer Service to assist you better when you contact them.

Faults and Warnings

When a fault or warning message appears, you can acknowledge the message to clear the screen. To acknowledge a fault or warning message, press the Enter button on the System Control Panel. This action does not clear the fault or warning condition, so you should consult Table 4-3 and Table 4-4 for suggested actions after you have acknowledged the message. Refer to the *System Control Panel Owner's Guide* for more information on faults and warnings.

Fault Types

There are three types of fault messages: automatic faults, manual faults, and escalating automatic faults. Table 4-1 describes how they differ in their behavior and how you can respond to them when they appear on the System Control Panel.

Table 4-1 Faults Types and Behaviors

Fault type	Behavior
Automatic faults	Clear automatically if the fault condition that generated the message goes away. You can also acknowledge automatic faults without waiting for them to clear automatically.
Manual faults	Require you to clear them by: <ul style="list-style-type: none"> • selecting Clear Faults on the RS3000 or on the device that generated the fault (if the fault condition still exists, the fault message reappears) • correcting the condition that caused the fault
Escalating automatic faults	Clear automatically if the fault condition goes away, just like an automatic fault. However, if an escalating automatic fault occurs several times within a defined time period, the escalating automatic fault becomes a manual fault, requiring user intervention. For example, if three faults occur in one minute, it will no longer clear itself but becomes a manual fault. Then you must identify the problem, correct the fault condition, and clear the fault or reset the device.

Warning Types

There are two types of warnings: automatic and manual. When the RS3000 detects a warning condition, it displays a warning message on the System Control Panel.

Table 4-2 describes how they differ in their behavior and in how you can respond to them when they appear on the System Control Panel.

Table 4-2 Warning Types and Behavior

Warning type	Behavior
Automatic warning	Clear automatically if the fault condition that generated the message goes away. You can also acknowledge automatic warnings without waiting for them to clear automatically.
Manual warning	Require you to acknowledge them before you can proceed with configuring or operating the RS3000. Manual warnings are usually in the form of a Yes/No question that you may acknowledge by pressing the Enter button on the System Control Panel for Yes and the Exit button for No. Refer to the <i>System Control Panel Owner's Guide</i> for more information.

Troubleshooting Reference

This chapter provides you with troubleshooting tips to identify and solve most problems that can occur with the RS3000.

This chapter is divided into the following four sections:

Section	Page Number
General Troubleshooting Guidelines	See page 4–5.
Warning Messages	See page 4–7.
Fault Messages	See page 4–10.
Inverter Applications (Loads)	See page 4–16.

General Troubleshooting Guidelines

This section will help you narrow down the source of any problem you may encounter. Please read the following troubleshooting steps:

1. Check for a Warning or Fault message on the System Control Panel. See “Warning Messages” on page 4–7 and “Fault Messages” on page 4–10 for descriptions of these messages and the specific actions to take. If a message is displayed, record it before doing anything further.
2. As soon as possible, record on the form, “Information About Your System” on page WA–4, the conditions at the time the problem occurred. These details should include the following as well as any other information asked for on page WA–4:
 - Loads the RS3000 was running or attempting to run
 - Battery condition at the time of failure (voltage, state of charge, for example), if known
 - Recent sequence of events (for example, charging had just finished, we disconnected shore power as were preparing to leave the RV park, but the inverter didn’t come on)
 - Any known unusual AC input factors such as low voltage or unstable generator output
 - Extreme conditions which may have existed at the time (temperature, vibrations, moisture, for example).
3. Attempt the solution indicated in Table 4-3 or Table 4-4.
4. If your RS3000 or System Control Panel is not displaying a Fault light, check the following list to make sure that the present state of the installation allows proper operation of the unit:
 - Is the inverter/charger located in a clean, dry, adequately ventilated place?
 - Have the AC input breakers opened? If so, your pass through load may have exceeded the rating of one or more of the input breakers.
 - Are the battery cables adequately sized and short enough?
 - Is the battery in good condition and are all DC connections tight?
 - Are the AC input and output connections and wiring in good condition?
 - Are the configuration settings correct for your particular installation?
 - Are the display panel and the communications cable properly connected and undamaged?

- Is the battery temperature sensor and its cable properly connected and undamaged?
- 5. Contact Xantrex Customer Service for further assistance. Please be prepared to describe details of your system installation and provide the model and serial number of the unit. See “Contact Information” on page v for contact information.

Warning Messages

Warning messages appear on the System Control Panel to alert you to an impending system change. You can retrieve and view the last ten warning messages using the control panel. The warnings have been recorded with a time stamp to let you know the date and time that the warning appeared. See “Warning Types” on page 4–3 for an explanation of automatic and manual warnings.

You can view the most recent fault messages of the RS3000 (up to 20) by selecting Fault Log from the Device Info menu in the RS3000 Advanced Menu.

If several warning messages occur before you can acknowledge or clear them, they are displayed together on a warning list. This list contains messages from every Xanbus-enabled device, not just the RS3000. You can select a message and view its details from warning list.

To view a message from a warning list:

1. On the list, use the up arrow or down arrow button to highlight the message you want to view.
2. Press Enter.

The complete message appears.

After viewing the message, you can return to the warning list by pressing Exit or continue to the menu for the device that caused the fault by pressing Enter. Each time you return to the list after viewing a complete message, the viewed message is removed from the list.

If you have left the warning list, you can view them at any time from the System Settings menu.

To view a fault list:

1. On the Select Device menu, highlight System and press Enter.
2. On the System Settings menu, highlight View Warning List.
3. Press Enter.

Table 4-3 provides a detailed description of the warning messages and solutions.

Table 4-3 Warning Messages

Warning Number	Message	Warning Type	Cause	Solution
W0	FET1 over-temp. Check airflow around it.	Automatic	FET1 Over Temperature Warning	Ensure adequate ventilation around the RS3000. Reduce the AC loads.
W1	FET2 over-temp. Check airflow around it.	Automatic	FET2 Over Temperature Warning	Ensure adequate ventilation around the RS3000. Reduce the AC loads.
W2	Bulk cap. over-temp. Check airflow around it.	Automatic	DC Bulk Capacitor Over Temperature Warning	Ensure adequate ventilation around the RS3000. Reduce the AC loads.
W3	Transf'r over-temp. Check airflow around it.	Automatic	Transformer Over Temperature Warning	Ensure adequate ventilation around the RS3000. Reduce the AC loads.
W4	Battery over-temp. Check battery settings.	Automatic	Battery Over Temperature Warning	Check battery voltage and battery cable connections. Stop charging, if necessary. Check for excessive ambient temperature and adequate ventilation in the battery compartment
W5	Over-temperature. Check airflow around it.	Automatic	Ambient Over Temperature Warning	Ensure adequate ventilation around the RS3000. Reduce charge rate or AC load.
W6	Too many AC loads. Turn some off.	Automatic	AC Overload Warning (AC OUTPUT)	Turn off some AC loads.
W7	You have enabled system restart after faults.	Automatic	Auto Restart After Fault Feature Enabled. (This parameter is not accessible through the System Control Panel. In the future, this feature may be configurable with advanced panels.)	If in invert mode, the unit may start up unexpectedly.
W8	You have enabled battery equalization. See manual.	Automatic	Equalization Enabled Warning	Make sure voltage sensitive loads are disconnected from batteries.

Table 4-3 Warning Messages

Warning Number	Message	Warning Type	Cause	Solution
W9	Battery temp sensor not detected. Check connections.	Automatic	Battery Temperature Sensor Not Present	Install a battery temperature sensor (BTS). This warning will continue to display as long as no BTS is connected.
W10	Battery temp sensor failure.	Automatic	Battery Temperature Sensor Shorted	Replace battery temperature sensor.
W11	Batt voltage too high. Check DC wiring to inverter/charger.	Automatic	DC Over Voltage Warning	Turn off or check additional charging sources to batteries. Check battery cables.
W12	Battery voltage is getting low. Recharge battery.	Automatic	DC Under Voltage Warning	Recharge batteries and check battery cables from inverter to batteries for loose connections.
W13	Line 1 AC voltage too high. System may shut down	Automatic	AC Over Voltage Warning (AC Line 1 input)	Check AC input voltage. Check high AC input voltage setting.
W14	Line 1 AC voltage too low. System may shut down.	Automatic	AC Under Voltage Warning (AC Line 1 input)	Check AC input voltage. Check low AC input voltage setting.
W15	Line 2 AC voltage too high. System may shut down.	Automatic	AC Over Voltage Warning (AC Line 2 input)	Check AC input voltage. Check high AC input voltage setting.
W16	Line 2 AC voltage too low. System may shut down.	Automatic	AC Under Voltage Warning (AC Line 2 input)	Check AC input voltage. Check low AC input voltage setting.
W18	Cannot Equalize	Manual	Cannot equalize	Wrong battery type. Change battery type only if the battery type setting is not the same as actual battery type. Cannot equalize a gel or AGM battery.
W19	Equalization terminated abnormally	Manual	Equalization terminated abnormally	Investigate cause of problem.
W500	Lost network connection	Automatic	Lost network connection	Check network cables or terminators.
W501	Inv/Chg is trying to fix a memory problem	Manual	Non-volatile memory warning	Normal operation may return or may go to fault. Push Reset button if normal operation does not resume.

Fault Messages

When the RS3000 detects a fault condition, the fault is displayed on the System Control Panel and also is indicated by the illuminated red Fault light on the RS3000 front panel. A fault affects the operation of the unit. See “Fault Types” on page 4–2 for an explanation of the different fault types.

You can view the 20 most recent fault messages of the RS3000 by selecting Fault Log from the Device Info menu in the RS3000 Advanced Menu.

If several faults occur before you can acknowledge or clear them, they are displayed together on a warning list. This list contains messages from every Xanbus-enabled device, not just the RS3000. You can select a message and view its details from the fault list.

To view a message from a fault list:

1. On the list, use the up arrow or down arrow button to highlight the message you want to view.
2. Press Enter.

The complete message appears.

After viewing the message, you can return to the fault list by pressing Exit or continue to the menu for the device that caused the fault by pressing Enter. Each time you return to the list after viewing a complete message, the viewed message is removed from the list.

If you have left the fault list, you can view them at any time from the System Settings menu.

To view a fault list:

1. On the Select Device menu, highlight System and press Enter.
2. On the System Settings menu, highlight View Fault List.
3. Press Enter.

Table 4-4 provides a detailed description of the fault messages and solutions. If you are unable to resolve the problem after referring to this table, contact your dealer or Customer Service.

Table 4-4 Fault Messages

Fault Number	Message	Fault Type	Cause	Solution
F0	Unit is too hot and has shut down. See guide.	Automatic	FET1 Over Temperature Shutdown	Clear the fault and attempt restart. Ensure adequate ventilation around the RS3000. Reduce AC loads.
F2	Unit is too hot and has shut down. See guide.	Automatic	FET2 Over Temperature Shutdown	Clear the fault and attempt restart. Ensure adequate ventilation around the RS3000. Reduce AC loads.
F3	Unit is too hot and has shut down. See guide.	Automatic	Transformer Over Temperature Shutdown	Clear the fault and attempt restart. Ensure adequate ventilation around the RS3000. Reduce AC loads.
F4	Battery over-temp. Inv/Chg has shut down. See guide.	Automatic	Battery Over Temperature Shutdown	Clear the fault and attempt restart. Stop charging, check battery voltage and temperature. Check for excessive ambient temperature and adequate ventilation in the battery compartment.
F5	is too hot and has shut down. See guide.	Automatic	Ambient Over Temperature Shutdown	Clear the fault and attempt restart. Ensure adequate ventilation around RS3000. Reduce AC loads.
F6	Too many AC loads. Turn some off, clear fault, try again.	Escalating Auto Fault. Must occur 3 times in 30 seconds before becoming a manual fault.	AC Overload Shutdown (AC OUTPUT)	Clear the fault and attempt restart. Reduce AC loads. Check that AC input wiring is not connected to the AC output.

Troubleshooting

Table 4-4 Fault Messages

Fault Number	Message	Fault Type	Cause	Solution
F7	Too many AC loads. Turn some off, clear fault, try again.	Escalating Auto Fault. Must occur 3 times in 30 seconds before becoming a manual fault.	AC Overload (PEAK CURRENT) Shutdown (AC OUTPUT)	Clear the fault and attempt restart. Reduce AC loads. Check that AC input wiring is not connected to the AC output.
F8	Unit has lost input neutral connection. See guide.	Manual	Neutral loss shutdown	Clear the fault and attempt restart. Check AC input wiring for presence of a proper neutral connection and ground connection. Check the AC input source to make sure the neutral is bonded to ground.
F9	Battery voltage is too high. See guide.	Automatic	DC Over Voltage Shutdown	Clear the fault and attempt restart. Ensure battery voltage is 10–16 VDC at RS3000 terminals. Check all other charging source outputs, battery cables.
F10	Battery is too low, can't invert. Recharge battery.	Automatic	DC Under Voltage Shutdown (Immediate) occurs if DC voltage is below 8 volts DC	Clear the fault and attempt restart. Recharge batteries. Check battery cable connections.
F11	Battery is too low, can't invert. Recharge battery.	Automatic	DC Under Voltage Shutdown occurs if DC voltage is below 10 volts DC.	Clear the fault and attempt restart. Recharge batteries. Check battery cable connections.
F12	Input AC too high. Check source, clear fault, try again.	Automatic	AC Over Voltage Shutdown (AC Line 1 input)	Clear the fault and attempt restart. Check AC input voltage. Check and adjust AC input high voltage settings.
F13	Input AC too low. Check source, clear fault, try again.	Automatic	AC Under Voltage Shutdown (AC Line 1 input)	Clear the fault and attempt restart. Check AC input voltage. Check and adjust AC input low voltage setting.

Table 4-4 Fault Messages

Fault Number	Message	Fault Type	Cause	Solution
F14	Input AC too high. Check source, clear fault, try again.	Automatic	AC Over Voltage Shutdown (AC Line 2 input)	Clear the fault and attempt restart. Check AC input voltage. Check and adjust AC input high voltage settings.
F15	Input AC too low. Check source, clear fault, try again.	Automatic	AC Under Voltage Shutdown (AC Line 2 input)	Clear the fault and attempt restart. Check AC input voltage. Check and adjust AC input low voltage setting.
F16	AC input frequency problem. Check gen for overspeed.	Automatic	AC Over Frequency Shutdown (AC Line 1 input)	Clear the fault and attempt restart. Check AC input frequency. Check and adjust AC input high frequency setting.
F17	AC input frequency problem. Check gen for underspeed.	Automatic	AC Under Frequency Shutdown (AC Line 1 input)	Clear the fault and attempt restart. Check AC input frequency. Check and adjust AC input low frequency setting.
F18	AC input frequency problem. Check gen for overspeed.	Automatic	AC Over Frequency Shutdown (AC Line 2 input)	Clear the fault and attempt restart. Check AC input frequency. Check and adjust AC input high frequency setting.
F19	AC input frequency problem. Check gen for underspeed.	Automatic	AC Under Frequency Shutdown (AC Line 2 input)	Clear the fault and attempt restart. Check AC input frequency. Check and adjust AC input low frequency setting.
F23	Inverter/Charger internal failure. Service required.	Escalating Auto Fault. Must occur 3 times in 30 seconds before becoming a manual fault.	AC Over Voltage Shutdown (Inverter AC output)	Service required.

Troubleshooting

Table 4-4 Fault Messages

Fault Number	Message	Fault Type	Cause	Solution
F24	Inverter/Charger internal failure. Service required.	Escalating Auto Fault. Must occur 3 times in 60 seconds before becoming a manual fault.	AC Under Voltage Shutdown (Inverter AC output)	Service required.
F25	Inverter/Charger internal failure. Service required.	Escalating Auto Fault. Must occur 3 times in 30 seconds before becoming a manual fault.	Auxiliary Power Supply Over Voltage Shutdown	Service required.
F26	Inverter/Charger internal failure. Service required.	Escalating Auto Fault. Must occur 3 times in 30 seconds before becoming a manual fault.	Auxiliary Power Supply Under Voltage Shutdown	Service required.
F29	AC Backfeed fault: Service immediately.	Manual	AC Backfeed Shutdown	Service required.
F30	Unit is too cold and has shut down. See guide.	Manual	Battery Under Temperature Fault	Clear the fault and attempt one restart. Try restart again when ambient temperature is warmer or gently warm the battery.
F40	Internal fault. If fault persists, call Customer Support.	Manual	No IPC communication	Service required.
F41	Internal fault. Reset. If fault persists, call Customer Support.	Manual	Dead battery charger timeout	Try restarting dead battery charging once. Then check the condition of the battery and replace if necessary.

Table 4-4 Fault Messages

Fault Number	Message	Fault Type	Cause	Solution
F500	Silicon Serial ID Failure	Manual	Silicon Serial ID Failure	Service required.
F502	Watchdog reset error	Manual	Watchdog reset error	Service required.
F505	Controller fault	Manual	Controller fault	Service required.
F506	Wrong fault identifier	Manual	Wrong fault identifier	Service required.
F507	Wrong identifier	Manual	Wrong identifier	Service required.
F508	Invalid interrupt	Manual	Invalid interrupt	Service required.

Inverter Applications

The RS3000 performs differently depending on the AC loads connected to it. If you are having problems with any of your loads, read this section.

Resistive Loads

These are the loads that the inverter finds the simplest and most efficient to drive. Voltage and current are in phase, which means they are in step with one another. Resistive loads usually generate heat in order to accomplish their tasks. Toasters, coffee pots, and incandescent lights are typical resistive loads. It is usually impractical to run larger resistive loads—such as electric stove and water heaters—from an inverter due to their high current requirements. Even though the inverter may be able to accommodate the load, the size of battery bank required would be impractical if the load is to be run for long periods.

Motor Loads

Induction motors (motors without brushes) require two to six times their running current on start up. The most demanding are those that start under load (for example, compressors and pumps). Of the capacitor start motors (typical in drill presses, band saws for example), the largest you can expect to run is 1 hp. Universal motors are generally easier to start. Since motor characteristics vary, only testing will determine whether a specific load can be started and how long it can be run.

If a motor fails to start within a few seconds or loses power after running for a time, it should be turned off. When the inverter attempts to start a load that is greater than it can handle, the inverter will turn itself off after a few seconds.

Problem Loads

Very Small Loads

If the power consumed by a device is less than the threshold of the Load Sense mode circuitry, and load sense is enabled, the inverter will not run. Most likely the solution will be to disable the Load Sense mode feature or lower the sense threshold. Refer to Xantrex Tech Note TN3 (979-0003-01-01) for more information.

Fluorescent Lights & Power Supplies

Some devices cannot be detected when scanned by Load Sense circuitry. Small fluorescent lights are the most common example. Some computers and sophisticated electronics have power supplies that do not present a load until line voltage is available. When this occurs, each unit waits for the other to begin. To drive these loads, either a small companion load like a light bulb rated for more than the load sense setting must be used to bring the inverter out of its search mode, or the inverter may be programmed to remain on by disabling the Load Sense feature. (See “Load Sense” on page 3–19.)

Clocks

You may notice that your clocks may not be accurate. Some of the clocks on your appliances may reset when the inverter/charger is in load sense mode.

Searching

When the inverter is in Load Sense (search) mode, it may fail to start some loads even though the rated wattage on the load is more than the load sense setting. Apply an additional load (companion load) to make the inverter exit Load Sense mode.

A

Specifications

Appendix A, “Specifications” contains the electrical and physical specifications for the RS3000 Sine Wave Inverter/Charger.

All specifications are subject to change without notice.

Inverter Specifications

All inverter specifications are at nominal conditions: ambient temperature of 77 °F (25 °C), 3000 watt resistive load, 12 volts DC inverting on the RS3000, 120 volts AC, unless otherwise specified.

Table A-1 Inverter Specifications

Output wave form	Sine wave
Total harmonic voltage distortion	<3%
Output power	up to 3000 W/3000 VA
Surge rating	7500 W/7500 VA for 5 seconds
AC output voltage	120 VAC \pm 5%
Input DC voltage rating	12 VDC nominal, 10 to 16 VDC
AC output frequency	60.0 \pm 0.05 Hz
Power factor (lag or lead)	0 to 1.0
Peak efficiency	>89%
Efficiency at 3000W	>85%
No load power draw	Load sense On <14W Load sense Off <60W
DC low voltage shutdown	10 volts
DC over voltage shutdown	16 volts

Charger Specifications

All charging specifications are at nominal conditions: ambient temperature of 77 °F (25 °C), 120 VAC, 60 Hz input, unless otherwise specified.

Table A-2 Charger Specifications

Charging method	<ul style="list-style-type: none"> • Three-stage charge (Bulk, Absorption, Float) • Two-stage charge (Bulk, Absorption) The default charging method is three-stage.
Without a battery temperature sensor	Three settings with the following temperature values: <ul style="list-style-type: none"> • Cool 50 °F (10 °C) • Warm 77 °F (25 °C) • Hot 104 °F (40 °C) The default value for this setting is Hot, and it can only be changed by a dealer, factory, or service centre.
With a battery temperature sensor	The temperature compensation coefficients on a 12 volt battery are as follows: <ul style="list-style-type: none"> • Flooded: 27 mV × (25 °C – BTS °C) • Gel: 27 mV × (25 °C – BTS °C) • AGM: 21 mV × (25 °C – BTS °C)
Equalization cycle	Yes, manual via System Control Panel
Number of independent battery banks	1
Battery bank size settings	50 – 2000 Ahr
Battery type settings	Flooded, AGM, Gel, Custom
Power factor corrected charging	Yes
Input power factor at full charge rate	> 0.95
AC input voltage	90 – 135 VAC
AC input frequency	60 Hz nominal, 55 – 65 Hz operating range
Minimum battery voltage	3.0 VDC
Maximum DC output voltage	16.0 VDC
Charger efficiency	≥ 85%
Maximum charge current	150 A

Transfer and General Specifications

All transfer specifications are at nominal conditions: ambient temperature of 77 °F (25 °C), 120 VAC, 60 Hz input, unless otherwise specified.

Table A-3 Transfer and General Specifications

Transfer time—utility to invert	20 ms
Minimum AC input voltage for transfer	90 VAC RMS
Maximum AC input voltage for transfer	135 VAC RMS
Minimum AC input frequency for transfer	55 Hz
Maximum AC input frequency for transfer	65 Hz
Cooling	Fan-cooled, temperature controlled.
Network power supply	800 mA at 15 VDC
Supported AC input types	Split phase (up to 50 amps per line) Dual input (up to 30 amps per line)

Environmental Specifications

Table A-4 Environmental Specifications

Nominal Ambient temperature	77 °F (25 °C)
Full Power Operating Ambient Temperature Range	–4 ° to 122 °F (–20 ° to 50 °C)
Maximum Operating Temperature	140 °F (60 °C) See “Invert Power Derating vs Ambient Temperature” on page A-6.
Storage temperature range	–40 ° to 185 °F (–40 to 85 °C)
Humidity: Operation/Storage	≤ 95% RH, non-condensing

Physical Specifications with Projections

Table A-5 Physical Specifications

Length	16.19 inches (411 mm)
Width	14.20 inches (361 mm)
Height	8.1 inches (208 mm)
Weight	75 lbs (34 kg)

Regulatory Approvals

Safety	CSA certified to CSA C22.2 No. 107.1 and UL 458
EMC	FCC and Industry Canada Class B

Fan Operation

The internal cooling fans are automatic temperature-controlled.

Important: This internal temperature of the inverter/charger may be caused by heat in the inverter/charger or by high ambient temperature.

The bottom fan is an exhaust fan and runs continuously.

Invert Power Derating vs Ambient Temperature

The inverter/charger delivers up to 3000 watts of sine wave output power. See Figure A-1 for temperature derating information.

If the unit is in elevated ambient temperature above 50 °C, you are required to reduce power draw according to Figure A-1 to avoid over-temperature shutdown.

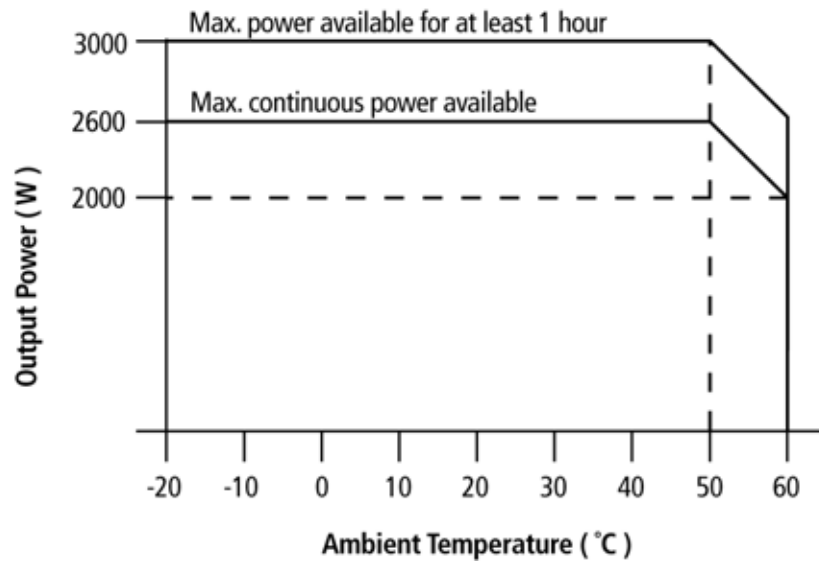

Figure A-1 Inverter Output Power vs Ambient Temperature

Charger Mode

Charger output (bulk mode) is 150 amps DC to 50 °C ambient. In higher ambients, the charger will automatically derate (reduce output current) to maintain internal temperatures at a safe level. Output at 60 °C ambient is approximately 75 amps.

B

Battery Charging Reference

Appendix B, “Battery Charging Reference” describes the multistage charging algorithm (formula) of the RS3000.

Charging Algorithms (Formulas)

Battery Type

	RS3000 charges flooded (or wet) lead-acid, gel, AGM (absorbed glass mat), and custom batteries. See “Batt Type” on page 3–16 for information on selecting your battery type.
Flooded (or wet)	Flooded (or wet) batteries have removable battery caps for refilling with distilled water and testing the electrolyte.
Gel	Gel batteries have the electrolyte in the form of a gel rather than a liquid and do not require topping up. Gel batteries are sealed and the battery caps are not removable.
AGM	AGM (absorbed glass mat) batteries are similar to gel batteries except that the electrolyte is absorbed into a fiberglass matting.
Custom	Custom is configured by the dealer, factory, or service center for battery types other than those listed above.



WARNING: Risk of battery damage

Since the RS3000 has only one battery type setting for all batteries connected to its bank, *do not mix* battery types. All connected batteries should be of one kind: Flooded (or wet) *or* Gel *or* AGM *or* Custom.

Charge Algorithm Stages

Three-Stage charging

If three-stage charging is enabled, the RS3000 will charge batteries in a sequence known as three-stage charging. The charging voltage delivered to the battery depends on the battery:

- type setting
- temperature (by switch setting or battery temperature sensor)
- state of charge

The three automatic stages are:

- bulk
- absorption
- float

See Figure B-1 for a graph of the three-stage charging profile.

There is a fourth stage, equalization, which is initialized manually as it is only performed occasionally and only on flooded (or wet) batteries.

Bulk Charge

In the first stage—the bulk charge—RS3000 delivers its full-rated output current. This constant current is delivered to the batteries until the battery voltage approaches its gassing voltage—typically around 13.5 volts for 12 volt batteries. The bulk charge stage restores about 75% of the battery’s charge.

The exit from bulk stage to the next stage, absorption, occurs under the following condition:

- battery voltage is more than the gassing voltage (V_G) for a specified amount of time (3 minute default).

With an AC reconnect to qualified AC from the utility power or a generator during the bulk stage, the unit will return to the bulk stage.

Absorption Charge

During the first part of absorption charge, the RS3000 delivers its full rated output current until the absorption voltage is reached. At this point, the RS3000 will transition to a constant voltage mode by keeping the charge voltage constant at the absorption voltage level, and the battery gradually reduces the charging current it demands as the battery attains full charge.

The absorption stage has the following exit criteria:

- Overall time in absorption timeout (ΔT_A) has a default of 6 hours.
- Time in constant voltage absorption timeout (ΔT_{CV}) has a default of 1 hour.
- Charge current level drops below a specified limit (I_H) for a specified amount of time, which has a default of 2% of C in Ah for 3 minutes.

See “Charge Algorithm Definitions” on page B-5 for more information.

With an AC reconnect during the absorption stage, the unit will transition to the float stage for three-stage charging and no-float stage for two-stage charging.

Float Charge

In the third stage—the float charge—which is a maintenance mode, the output voltage of the charger is reduced to a lower level, typically about 13.5 (V_{F1}) volts to maintain the battery's charge without losing electrolyte through gassing.

With AC reconnected during this stage, the unit will return to the float stage.

Equalization Charge

The equalization charge must be manually initiated from the System Control Panel because it is not required each time the battery is recharged. Equalization is a deliberate overcharge designed to return each cell to optimum condition by reducing sulfation and stratification in the battery. The overcharge helps the battery to reach and maintain peak capacity.

An equalization charge should be performed *only* on flooded, vented (non-sealed or “wet”) batteries. It should be performed only if recommended by the battery manufacturer and only as often as specified.

After initiating an equalize charge cycle, the charger will always execute a bulk and absorption charge stage before starting the actual equalize charge stage. The equalize charge stage has a default current and voltage setpoint at 10% of C in Ah and 15.5 VDC, respectively. During the equalize charge stage, the charger will produce current equal to the current setpoint as long as the battery voltage is still less than the voltage setpoint. When the voltage setpoint is reached, the charger will change its current output to keep the battery voltage steady at the voltage setpoint level.

There is a timeout (default is 1 hour) for the equalize charge stage. The charger will exit equalize after the timeout has occurred, even if the voltage setpoint has not been reached. Should another equalize cycle be required, it has to be manually initiated from the System Control Panel.

Should an AC reconnect occur during the equalize charge stage, the charger will return to the float/no-float charge stage, depending on which one is selected.

Two-Stage Charging

If the two-stage charge is enabled, the charger finishes the absorption charge but does not go to float mode because some battery manufacturers advise against floating their batteries. The RS3000 goes into a monitoring mode instead where the charger monitors the batteries but does not float them.

A new two-stage charge cycle will be initiated under the same conditions as for three-stage charging.

Charge Algorithm Graph

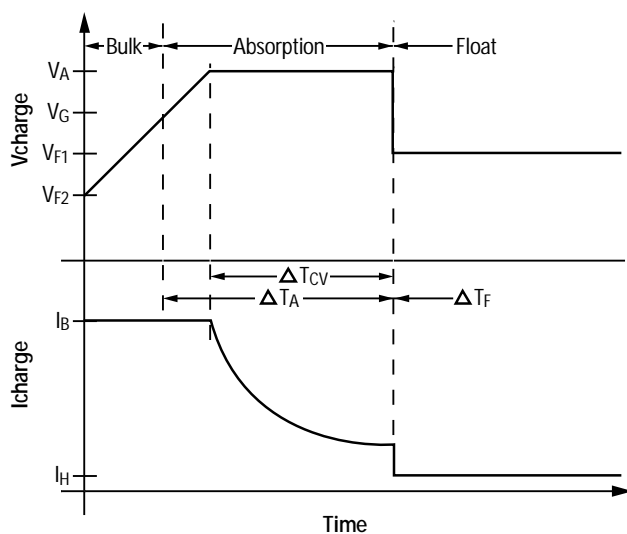

Figure B-1 Three-Stage Charging Profile

Charge Algorithm Definitions

Table B-1 Battery Defaults

Voltage		Flooded (or wet)	Gel	AGM
V_A	Absorption Voltage (VDC)	14.4	14.4	14.3
V_G	Gassing Voltage (VDC)	13.5	13.8	13.45
V_{F1}	Float Voltage (VDC)	13.5	13.8	13.45
V_{F2}	Float Exit Voltage (VDC)	12.5	12.5	12.5
V_E	Equalize Voltage (VDC)	15.5	NA	NA

Table B-1 (cont.)

Current		Flooded (or wet)	Gel	AGM
I_B	Bulk Current (ADC)	20% Ah	20% Ah	20% Ah
I_H	Absorption Exit Current (ADC)	2% Ah	2% Ah	2% Ah
I_E	Equalize Current (ADC)	10% Ah	NA	NA
Time		Flooded (or wet)	Gel	AGM
ΔT_A	Absorption Timeout (hours)	6	6	6
ΔT_{CV}	Constant Voltage Absorption Timeout (hours)	1	1	1
ΔT_F	Float Timeout (days)	21	21	21
ΔT_E	Equalize Timeout (hours)	1	NA	NA

The numbers presented in Table B-1 and elsewhere in this guide are base numbers only and will vary with factors such as temperature compensation and battery type.

Important: The custom battery factory defaults are the same as for an AGM battery.

Battery Charger Interruption

If battery charging is interrupted in bulk charge (for example, AC is disconnected, or a fault occurs), the unit will return to bulk charge when battery charging resumes.

If battery charging is interrupted in any stage other than bulk, the unit will go to float charge when battery charging resumes.

However, if any of two conditions occur, a new bulk charge cycle is initiated when battery charging begins:

- the battery drops below 12.5 VDC for 15 minutes (V_{F2}). The 15 minute countdown is independent of mode: inverting, bulk charging, float charging, for example.
- 21 days have passed from the time the charger completed Absorption (ΔT_F).

C

Terminology

This section provides a glossary of terms and a listing of abbreviations used in this guide.

Glossary

Absorption Charge	The second stage of three-stage battery charging. Voltage remains constant and current reduces as the battery becomes charged. This ensures complete charging.
Alternating Current (AC)	The type of electrical power supplied by the power utility or an AC generator. The unique characteristic of this form of electricity is that it reverses direction at regular intervals. For example, 120 VAC 60 Hz power reverses flow 60 times a second, hence the rating 60 Hz (cycles per second).
Ambient Temperature	Refers to the air temperature around the inverter, which will affect its output power.
Ampere (Amp)	A measurement of the flow of electrical current. One amp is equal to the current that flows when one volt is acting across the resistance of one ohm. (Ohm's law: $I = V/R$ where I=current, V=volts, R=resistance)
Ampere Hour (Amp Hour/Ah)	One amp of electrical current flowing for one hour. One way to measure the capacity of batteries.
Bulk Charge	The first stage of three-stage battery charging. Current is supplied to the batteries at a constant rate while voltage gradually rises.
Charger, DC	A device that is used to replenish the capacity of a battery (its "charge") by supplying DC current to the battery.
Current	The rate of flow of electrical charge measured in amps.
Direct Current (DC)	The type of electricity stored in batteries and generated by solar electric devices. Current flows in a single direction without alternating.
Disable	When a function is disabled, it is not allowed to occur and if it is occurring, it is terminated. Regardless of other conditions, the function will not be activated. For example, even if AC power is present, if the charger is disabled, the unit will not charge. The charger must be enabled. See "Enable" in the glossary.
Discharge	Stored energy being released from a battery
Dual Input	The dual input has two line inputs, one neutral and one ground. The voltage between each line and the neutral is 120 VAC. The voltage between the two line inputs is 0 VAC. (Unlike the split phase type, the two lines are in phase, not out of phase, with each other.)

DC Loads	These loads are those that run off a DC electrical system (battery). A few examples of DC loads are pumps, lights, fans, power vents, toilet, inverters, and some water heaters. DC loads rely on the batteries for power.
Electrolyte	The liquid found inside storage batteries. Electrolyte is a conductive medium in which the flow of electricity takes place. In lead-acid batteries, the electrolyte is an acid-water mixture.
Enable	When a function is enabled, it is allowed to occur but other conditions may have to be met before the function is activated or turned on. For example, the charger function on the RS3000 may be enabled, but it will not charge unless qualified AC power is present.
Float Charge	The third stage of three-stage battery charging. After batteries reach full charge, charging voltage is reduced to a lower level to prevent gassing and to prolong battery life. This stage is often referred to as a maintenance charge. Rather than charging a battery, it keeps an already-charged battery from discharging while providing load current.
Hertz (Hz)	The frequency, or number of times per second, that the flow of AC electricity reverses itself. Also referred to as cycles per second (see alternating current).
Idle Current	The amount of electrical current drawn from the battery to keep an inverter running without a load.
Inductive Loads	TVs, VCRs, stereos, computers, and electric motors (power tools, vacuum cleaners, for example) are examples of inductive loads which surge on start up. They require a high startup current compared to a resistive load such as a toaster or a coffee pot.
Inverter	A device that converts DC power to AC power.
Light Emitting Diode (LED)	An LED is a type of solid-state lamp used to display various status functions.
Load	Any device that consumes electricity in order to operate. Appliances, tools, and lights are examples of electrical loads. There are different types of loads such as AC loads and DC loads.
Low Battery Protection	A control circuit that minimizes the flow of electricity from batteries to the inverter when battery voltage drops below a determined level.
National Electric Code	The electrical wiring and installation code used in the United States (NFPA 70).

Terminology

Overload/Over-current Protection	A control circuit designed to protect a device (wire, inverter or charger, for example) from loads exceeding its capacity. A fuse, for example, is an over-current protection device. All Xantrex inverters have internal circuitry to protect themselves from overload/over-current conditions.
Parallel Wiring	A group of electrical devices, such as batteries or PV modules, wired together to increase current, while voltage remains constant. Two 100 amp-hour 12 VDC batteries wired in parallel form a 200 amp-hour 12 VDC battery bank.
Resistive Loads	Toasters, coffee pots, and incandescent lights are examples of resistive loads. They use a resistive heater element to generate heat or light.
Series Wiring	A group of electrical devices, such as batteries or PV modules, wired together to increase voltage, while current remains constant. Two 100 amp-hour 12 VDC batteries wired in series form a 100 amp hour 24 VDC battery bank.
Sine Wave	The standard waveform of electric utility AC power. A sine wave is a rounded, smooth waveform alternating above and below zero volts.
Split Phase	The split phase has two line inputs, one neutral and one ground. The voltage between each line and neutral is 120 VAC. The voltage between the two lines is 240 VAC. (The two lines are 180 degrees out of phase with each other.) The voltage between the neutral and the ground is approximately 0 VAC.
Surge Capacity	The amount of current an inverter can deliver for short periods of time. Most electric motors draw up to six to ten times their rated current when starting. An inverter will “surge” to meet these motor-starting requirements. Most Xantrex inverters have surge capacities at least twice their continuous ratings.
Transfer Switch, AC	A switch that selects between two sources of AC power and isolates those sources from each other.
Volts	A unit of measure of electric potential. Voltage is often explained using a liquid analogy, comparing water pressure to voltage. For example, a high pressure hose would be similar to high voltage.
Watt(s)	A measure of true electrical power. Watts are calculated by multiplying volts times amps for resistive loads. For non-resistive loads, watts are calculated by multiplying volts times amps times power factor. ($P=I \times V$, where P=power, I=current, V=volts)

Watt Hour (W/h)	Electrical power measured over a period of time. One watt hour of electricity is equivalent to one watt of power being consumed for one hour. A 3-watt light operated for 2 hours would consume 6 Wh (watt hour) of electricity.
Volt-amps (VA)	A measure of the “apparent” power equivalent to the true power (watts) in resistive loads, but exceeding watts in non-resistive loads. VA is calculated by multiplying volts times amps without using power factor.

Abbreviations

Abbreviation	Full name	Definition
A	Ampere (Amps)	See Glossary.
AC	Alternating Current	See Glossary.
AGM	Absorbed Glass Mat	A type of battery in which the electrolyte or battery fluid is contained in glass-fibre mats between battery plates.
Ah	Ampere hour (amp hour)	See Glossary.
ASC	Authorized Service Center	ASC's are service centers affiliated with Xantrex to provide repair service.
AWG	American Wire Gauge	A standard used for indicating wire size: the larger the AWG number, the smaller the wire size.
BTS	Battery Temperature Sensor	A BTS is a device attached to a battery and inverter/charger to ensure that charge delivered to the batteries is adjusted according to their actual temperatures.
CEC	Canadian Electric Code	The CEC is the Canadian national electrical code providing the industry standard for safe electrical installations.
CSA	Canadian Standards Association	A standards writing and certification body which tests and approves products for regulatory compliance to international standards.
DC	Direct Current	See Glossary.
EMC	Electro-Magnetic Compatibility	The ability of an electronic device to operate without causing or suffering from radio frequency interference.
FCC	Federal Communications Commission	US agency which regulates EMC and television, radio, wireless, cable, and satellite in the US.
GFCI	Ground Fault Circuit Interrupter	GFCI is a device that protects against electric shock. A GFCI trips and stops the flow of power when leakage current is detected.
Hz	Hertz	See Glossary.
LED	Light Emitting Diode	See Glossary/
mA	Milliamps	1/1000 of an amp
NEC	National Electric Code	See Glossary.
RMA	Return Material Authorization	The authorization provided to a customer to return materials to Xantrex.
RMS	Root Mean Square	A measure of the effective value of an alternating (AC) voltage, current or power.

Abbreviation	Full name	Definition
SOC	State of charge	Indicates the quantity of electrical energy stored inside a battery.
UL	Underwriters Laboratory	A standards writing and certification body which tests and approves products for regulatory compliance to international standards.
THD	Total Harmonic Distortion	A measure of how pure or clean a waveform is.
VAC	Volts Alternating Current	See Alternating Current in Glossary.
VDC	Volts Direct Current	See Direct Current in Glossary.
W	Watts	See Glossary.
°C	Degrees Celsius	Temperature system that uses 0 °C for the freezing point and 100 °C for the boiling point of water.
°F	Degrees Fahrenheit	Temperature system that uses 32 °F as the freezing point and 212 °F as the boiling point of water.

Warranty and Return Information

Warranty

What does this warranty cover? This Limited Warranty is provided by Xantrex Technology, Inc. ("Xantrex") and covers defects in workmanship and materials in your RS3000 Sine Wave Inverter/Charger. This warranty period lasts for 36 months from the date of purchase at the point of sale to you, the original end user customer. You require proof of purchase to make warranty claims.

This Limited Warranty is transferable to subsequent owners but only for the unexpired portion of the Warranty Period. Subsequent owners also require proof of purchase.

What will Xantrex do? Xantrex will, at its option, repair or replace the defective product free of charge, provided that you notify Xantrex of the product defect within the Warranty Period, and provided that Xantrex through inspection establishes the existence of such a defect and that it is covered by this Limited Warranty.

Xantrex will, at its option, use new and/or reconditioned parts in performing warranty repair and building replacement products. Xantrex reserves the right to use parts or products of original or improved design in the repair or replacement. If Xantrex repairs or replaces a product, its warranty continues for the remaining portion of the original Warranty Period or 90 days from the date of the return shipment to the customer, whichever is greater. All replaced products and all parts removed from repaired products become the property of Xantrex.

Xantrex covers both parts and labor necessary to repair the product, and return shipment to the customer via a Xantrex-selected non-expedited surface freight within the contiguous United States and Canada. Alaska and Hawaii are excluded. Contact Xantrex Customer Service for details on freight policy for return shipments outside of the contiguous United States and Canada.

How do you get service? If your product requires troubleshooting or warranty service, contact your merchant. If you are unable to contact your merchant, or the merchant is unable to provide service, contact Xantrex directly at:

Telephone: 1 800 670 0707 (toll free North America)
1 360 925 5097 (direct)

Fax: 1 800 994 7828 (toll free North America)
1 360 925 5143 (direct)

Email: customerservice@xantrex.com

Direct returns may be performed according to the Xantrex Return Material Authorization Policy described in your product manual. For some products, Xantrex maintains a network of regional Authorized Service Centers. Call Xantrex or check our website to see if your product can be repaired at one of these facilities.

What proof of purchase is required? In any warranty claim, dated proof of purchase must accompany the product and the product must not have been disassembled or modified without prior written authorization by Xantrex.

Proof of purchase may be in any one of the following forms:

- The dated purchase receipt from the original purchase of the product at point of sale to the end user, or
- The dated dealer invoice or purchase receipt showing original equipment manufacturer (OEM) status, or
- The dated invoice or purchase receipt showing the product exchanged under warranty

Warranty and Return

What does this warranty not cover? This Limited Warranty does not cover normal wear and tear of the product or costs related to the removal, installation, or troubleshooting of the customer's electrical systems. This warranty does not apply to and Xantrex will not be responsible for any defect in or damage to:

- a) the product if it has been misused, neglected, improperly installed, physically damaged or altered, either internally or externally, or damaged from improper use or use in an unsuitable environment;
- b) the product if it has been subjected to fire, water, generalized corrosion, biological infestations, or input voltage that creates operating conditions beyond the maximum or minimum limits listed in the Xantrex product specifications including high input voltage from generators and lightning strikes;
- c) the product if repairs have been done to it other than by Xantrex or its authorized service centers (hereafter "ASCs");
- d) the product if it is used as a component part of a product expressly warranted by another manufacturer;
- e) the product if its original identification (trade-mark, serial number) markings have been defaced, altered, or removed.

Disclaimer

Product

THIS LIMITED WARRANTY IS THE SOLE AND EXCLUSIVE WARRANTY PROVIDED BY XANTREX IN CONNECTION WITH YOUR XANTREX PRODUCT AND IS, WHERE PERMITTED BY LAW, IN LIEU OF ALL OTHER WARRANTIES, CONDITIONS, GUARANTEES, REPRESENTATIONS, OBLIGATIONS AND LIABILITIES, EXPRESS OR IMPLIED, STATUTORY OR OTHERWISE IN CONNECTION WITH THE PRODUCT, HOWEVER ARISING (WHETHER BY CONTRACT, TORT, NEGLIGENCE, PRINCIPLES OF MANUFACTURER'S LIABILITY, OPERATION OF LAW, CONDUCT, STATEMENT OR OTHERWISE), INCLUDING WITHOUT RESTRICTION ANY IMPLIED WARRANTY OR CONDITION OF QUALITY, MERCHANTABILITY OR FITNESS FOR A PARTICULAR PURPOSE. ANY IMPLIED WARRANTY OF MERCHANTABILITY OR FITNESS FOR A PARTICULAR PURPOSE TO THE EXTENT REQUIRED UNDER APPLICABLE LAW TO APPLY TO THE PRODUCT SHALL BE LIMITED IN DURATION TO THE PERIOD STIPULATED UNDER THIS LIMITED WARRANTY.

IN NO EVENT WILL XANTREX BE LIABLE FOR ANY SPECIAL, DIRECT, INDIRECT, INCIDENTAL OR CONSEQUENTIAL DAMAGES, LOSSES, COSTS OR EXPENSES HOWEVER ARISING WHETHER IN CONTRACT OR TORT INCLUDING WITHOUT RESTRICTION ANY ECONOMIC LOSSES OF ANY KIND, ANY LOSS OR DAMAGE TO PROPERTY, ANY PERSONAL INJURY, ANY DAMAGE OR INJURY ARISING FROM OR AS A RESULT OF MISUSE OR ABUSE, OR THE INCORRECT INSTALLATION, INTEGRATION OR OPERATION OF THE PRODUCT.

Exclusions

If this product is a consumer product, federal law does not allow an exclusion of implied warranties. To the extent you are entitled to implied warranties under federal law, to the extent permitted by applicable law they are limited to the duration of this Limited Warranty. Some states and provinces do not allow limitations or exclusions on implied warranties or on the duration of an implied warranty or on the limitation or exclusion of incidental or consequential damages, so the above limitation(s) or exclusion(s) may not apply to you. This Limited Warranty gives you specific legal rights. You may have other rights which may vary from state to state or province to province.

Warning: Limitations On Use

Please refer to your product manual for limitations on uses of the product.

SPECIFICALLY, PLEASE NOTE THAT THE RS3000 SINE WAVE INVERTER/CHARGER SHOULD NOT BE USED IN CONNECTION WITH LIFE SUPPORT SYSTEMS OR OTHER MEDICAL EQUIPMENT OR DEVICES. WITHOUT LIMITING THE GENERALITY OF THE FOREGOING, XANTREX MAKES NO

REPRESENTATIONS OR WARRANTIES REGARDING THE USE OF THE XANTREX RS3000 SINE WAVE INVERTER/CHARGER IN CONNECTION WITH LIFE SUPPORT SYSTEMS OR OTHER MEDICAL EQUIPMENT OR DEVICES.

Please note that the RS3000 Sine Wave Inverter/Charger is not intended for use as an uninterruptible power supply and Xantrex makes no warranty or representation in connection with any use of the product for such purposes.

Return Material Authorization Policy

Before returning a product directly to Xantrex you must obtain a Return Material Authorization (RMA) number and the correct factory "Ship To" address. Products must also be shipped prepaid. Product shipments will be refused and returned at your expense if they are unauthorized, returned without an RMA number clearly marked on the outside of the shipping box, if they are shipped collect, or if they are shipped to the wrong location.

When you contact Xantrex to obtain service, please have your instruction manual ready for reference and be prepared to supply:

- The serial number of your product
- Information about the installation and use of the unit
- Information about the failure and/or reason for the return
- A copy of your dated proof of purchase

Record these details on page WA-4.

Return Procedure

1. Package the unit safely, preferably using the original box and packing materials. Please ensure that your product is shipped fully insured in the original packaging or equivalent. This warranty will not apply where the product is damaged due to improper packaging.
2. Include the following:
 - The RMA number supplied by Xantrex Technology, Inc. clearly marked on the outside of the box.
 - A return address where the unit can be shipped. Post office boxes are not acceptable.
 - A contact telephone number where you can be reached during work hours.
 - A brief description of the problem.
3. Ship the unit prepaid to the address provided by your Xantrex customer service representative.

If you are returning a product from outside of the USA or Canada In addition to the above, you MUST include return freight funds and are fully responsible for all documents, duties, tariffs, and deposits.

If you are returning a product to a Xantrex Authorized Service Center (ASC) A Xantrex return material authorization (RMA) number is not required. However, you must contact the ASC prior to returning the product or presenting the unit to verify any return procedures that may apply to that particular facility.

Out of Warranty Service

If the warranty period for your RS3000 Sine Wave Inverter/Charger has expired, if the unit was damaged by misuse or incorrect installation, if other conditions of the warranty have not been met, or if no dated proof of purchase is available, your inverter may be serviced or replaced for a flat fee.

To return your RS3000 Sine Wave Inverter/Charger for out of warranty service, contact Xantrex Customer Service for a Return Material Authorization (RMA) number and follow the other steps outlined in "Return Procedure" on page WA-3.

Payment options such as credit card or money order will be explained by the Customer Service Representative. In cases where the minimum flat fee does not apply, as with incomplete units or units with excessive damage, an additional fee will be charged. If applicable, you will be contacted by Customer Service once your unit has been received.

Information About Your System

As soon as you open your RS3000 Sine Wave Inverter/Charger package, record the following information and be sure to keep your proof of purchase.

- Serial Number _____
- Purchased From _____
- Purchase Date _____

If you need to contact Customer Service, please record the following details before calling. This information will help our representatives give you better service.

- Type of installation (e.g. RV, truck) _____
- Length of time inverter/charger has been installed _____
- Battery/battery bank size _____
- Battery type (e.g. flooded (or wet), sealed gel cell, AGM) _____
- DC wiring size and length _____
- Description of indicators on front panel _____
- Appliances operating when problem occurred _____
- Description of problem _____

-
- Any fault or warning displayed if using a System Control Panel?

Index

A

- absorption charge B-3
- AC knockout
 - illustrated 1-9
 - locations of 1-7
- AC wiring compartment access panel 1-7
- AGM (absorbed glass mat) batteries B-2

B

- batteries
 - AGM (absorbed glass mat) B-2
 - custom B-2
 - flooded B-2
 - gel B-2
 - wet B-2
- battery damage, risk of B-2
- battery temperature sensor
 - charger operation 2-9
 - features 1-11
 - illustrated 1-11
- battery temperature sensor jack, described 1-9
- battery types, description of B-2
- bulk charge B-3

C

- charge algorithm definitions B-5
- charge algorithm graph B-5
- charge algorithm stages
 - three-stage B-2
 - two-stage B-5
- charger mode A-6
- charger operation, operating limits 2-12
- charging
 - battery temperature sensor 1-4
 - built-in charge formulas 1-4
 - dead battery 1-4
 - described 1-4
 - equalization 1-4
 - load management 1-4
- charging formulas. *See* charging algorithms. B-2
- chassis ground point, described 1-10
- configurable settings
 - how to select and adjust 3-8
- configuration sub-menus 3-18

- configure RS3000 menu
 - advanced 3-18
 - basic 3-12
- Customer Service
 - email v
 - fax number v
 - phone number v
 - preparing to call WA-4

D

- DC terminal covers 1-11
- DC terminals
 - described 1-10
 - negative 1-10
 - positive 1-10
- dead battery charging 1-4
- Down arrow button 2-4
- dual input
 - charging 1-3
 - defined C-2
- dual network jacks, described 1-10

E

- electronic protection 1-6
- Enter button 2-4
- equalization
 - precharging 3-15
 - procedure 2-10, 2-11
 - recommended frequency 2-10
 - terminating 2-11
- equalization charge B-4
- Ethernet incompatibility 1-9

F

- fan
 - bottom 1-7
 - operation A-5
 - top exhaust fan 1-7
 - top intake fan 1-7
- fault
 - automatic 4-2
 - definition 2-14, 4-10
 - escalating automatic 4-2

manual 2–14, 4–2
fault types 4–2
faults and warnings 4–2
FCC
 compliance A–5
 regulations x
firmware revision number, viewing 2–5
float charge B–4
Force Charge, defined 3–23
front panel
 described 1–7
 illustrated 1–7
front panel light
 Absorption 2–14
 Bulk 2–14
 Charger ON 2–13
 Equalize 2–14
 External AC 2–13
 Fault 2–13
 Float 2–14
 Inverter ON 2–13
 Low Battery 2–13
 Network 2–13
front panel lights and buttons
 described 1–8
 illustrated 1–8

H

hibernate mode 2–20
 bringing system out of 2–20
 when to use 2–20

I

Information about Your System form WA–4
invert power derating A–6
inverter
 purchase date WA–4
 serial number WA–4
inverter operation, operating limits 2–7
inverting, described 1–3

L

load sense
 configuring 3–19
 mode 1–3, 2–6
Load sense. See also sense below and sense interval

M

mounting flanges, described 1–9

P

power save mode
 entering and exiting 2–17
 when to use 2–16
power share, described 2–12
proof of purchase WA–4
protection features 1–6
purchase date WA–4

R

regulatory approvals A–5
RS3000 advanced menu, selecting 3–6
RS3000 basic menu
 example of 3–5
 returning to 3–7
 selecting 3–5
RS3000 device menu, described 3–10
RS3000 menu structure, illustrated 3–9

S

safe mode
 caution 2–17
 exiting 2–19
safety instructions vii
Select Device menu, viewing 3–4
sense below
 configuring 3–21
sense below. See also sense interval and load sense
sense interval
 configuring 3–22
sense interval. See also sense below and load sense
serial number WA–4
side panel features
 described 1–9
 illustrated 1–9
specifications
 charger A–3
 environmental A–4
 general A–4
 inverter A–2
 physical A–5
 transfer A–4
split phase
 charging 1–3
 defined C–4

- system button
 - described 2–15
 - illustrated 2–15
- system check
 - charging and inverting 2–5
- System Control Panel
 - buttons described 2–3
 - function of 2–2
 - illustrated 2–15
 - using 2–3
- system menu map 3–3
- system mode
 - operate 2–16
 - power save 2–16
- system screen, example of 3–4

T

- three-stage charging algorithm B–2
- three-stage charging profile, illustrated B–2
- troubleshooting
 - fault messages 4–10
 - general guidelines 4–5
 - motor loads 4–16
 - problem loads 4–16
 - resistive loads 4–16
 - warning messages 4–7

U

- Up arrow button 2–4

W

- warning
 - automatic 4–3
 - definition 2–14
 - manual 4–3
 - types 4–3
- warranty
 - out of warranty service WA–4
 - terms and conditions WA–1
- web site v

X

- Xanbus system
 - described 1–5
 - illustrated 1–5
- Xanbus-enabled 1–5
- Xantrex, web site v

Xantrex Technology Inc.

1 800 670 0707 Tel toll free NA
1 360 925 5097 Tel direct
1 800 994 7828 Fax toll free NA
1 360 925 5143 Fax direct
customerservice@xantrex.com
www.xantrex.com