



**ATTENTION! CHARGE BEFORE USE** 

CHARGE BATTERIES IMMEDIATELY AFTER PURCHASE AND AFTER EACH USE AND ONCE EVERY 3 MONTHS. FOR DETAILED INSTRUCTIONS, READ THE OWNERS GUIDE.

**ATTENTION! CHARGE AVANT UTILISATION**

CHARGEZ LES BATTERIES IMMÉDIATEMENT APRÈS L'ACHAT ET APRÈS CHAQUE UTILISATION ET UNE FOIS TOUS LES 3 MOIS. POUR DES INSTRUCTIONS DÉTAILLÉES, LIRE LE GUIDE DU PROPRIÉTAIRE.

**Owner's Guide**

# Xantrex Lithium-ion Battery

- Xantrex 310Ah 12V Battery  
**PN: 884-0310-12 | 884-0310-12-01**
- Xantrex 410Ah 12V Battery  
**PN: 884-0410-12 | 884-0410-12-01**
- Xantrex 205Ah 24V Battery  
**PN: 884-0205-24**

---

Copyright © 2021-25 Xantrex LLC. All Rights Reserved.

All trademarks are owned by Xantrex LLC and its affiliates.

Rebling is a trade name owned by Rebling Power Connectors, America's Power Connection.

**Exclusion for Documentation**

UNLESS SPECIFICALLY AGREED TO IN WRITING, SELLER

(A) MAKES NO WARRANTY AS TO THE ACCURACY, SUFFICIENCY OR SUITABILITY OF ANY TECHNICAL OR OTHER INFORMATION PROVIDED IN ITS MANUALS OR OTHER DOCUMENTATION;

(B) ASSUMES NO RESPONSIBILITY OR LIABILITY FOR LOSSES, DAMAGES, COSTS OR EXPENSES, WHETHER SPECIAL, DIRECT, INDIRECT, CONSEQUENTIAL OR INCIDENTAL, WHICH MIGHT ARISE OUT OF THE USE OF SUCH INFORMATION. THE USE OF ANY SUCH INFORMATION WILL BE ENTIRELY AT THE USER'S RISK; AND

(C) REMINDS YOU THAT IF THIS MANUAL IS IN ANY LANGUAGE OTHER THAN ENGLISH, ALTHOUGH STEPS HAVE BEEN TAKEN TO MAINTAIN THE ACCURACY OF THE TRANSLATION, THE ACCURACY CANNOT BE GUARANTEED. APPROVED CONTENT IS CONTAINED WITH THE ENGLISH LANGUAGE VERSION WHICH IS POSTED AT <https://www.xantrex.com>.

**NOTE:** Visit <https://www.xantrex.com>, click Products, select a Product category, select a Product, and search the Product Documents panel for a translation of the English guide, if available.

**Document Number:** 975-1044-01-01

Rev K

**Date:** February 2025

**Product Name and Part Number**

Xantrex 310Ah 12V Battery (884-0310-12 | 884-0310-12-01)

Xantrex 410Ah 12V Battery (884-0410-12 | 884-0410-12-01)

Xantrex 205Ah 24V Battery (884-0205-24)

**Contact Information**

**Telephone:** +1-800-670-0707 / +1-408-987-6030

**Email:** <https://xantrex.com/support/get-customer-support/>

**Web:** <https://www.xantrex.com>

**Information About Your System**

As soon as you open your product, record the following information and be sure to keep your proof of purchase.

Serial Number \_\_\_\_\_

Product Number \_\_\_\_\_

Purchased From \_\_\_\_\_

Purchase Date \_\_\_\_\_

---

## Purpose

The purpose of this Owner's Guide is to provide explanations and procedures for installing, operating, configuring, maintaining, and troubleshooting a Xantrex Lithium-ion Battery for Recreational, Commercial and Fleet Vehicle, or Marine installations.

## Scope

The guide provides safety and operating guidelines as well as information on installing and configuring the lithium-ion battery using the Xantrex App.

## Audience

The guide is intended for qualified personnel.

Qualified personnel have training, knowledge, and experience in:

- Installing electrical equipment.
- Applying all applicable installation codes.
- Analyzing and reducing the hazards involved in performing electrical work.
- Installing and configuring batteries (especially lithium-ion batteries, as applicable)
- Selecting and using Personal Protective Equipment (PPE) and following safety work code practices. See NFPA 70E or CSA Z462.

## Abbreviations and Acronyms

A	Amperes
Ah	Amp-hours (a unit of battery capacity)
AC	Alternating Current [~]
AGM	Absorbed Glass Mat (a battery type)
BLE	Bluetooth Low Energy
BMS	Battery Management System
BTS	Battery Temperature Sensor
DC	Direct Current [—]
h	Hours (a unit of time)
Hz	Hertz (a unit of frequency)
in-lb	inch-pound force (a unit of torque)
kW	Kilowatts (1000 watts)
LED	Light Emitting Diode
LFP	LiFePO <sub>4</sub> (lithium iron phosphate – a battery type)
m	Minutes (a unit of time)
max	Maximum
min	Minimum
ms	Milliseconds (a unit of time)
N-m	Newton-meters (a unit of torque)
PN	Product Number
PPE	Personal Protective Equipment
s	Seconds (a unit of time)

SOC, SoC	State-of-Charge of battery
V, VAC, VDC	Voltage, Volts AC, Volts DC
W	Wattage, watt (a unit of power)
°	Degrees symbol commonly used for temperature
°C	Unit of degrees in Celsius scale
°F	Unit of degrees in Fahrenheit scale
%	Percent, percentage

## Related Information

You can find more information about Xantrex products and services at <https://www.xantrex.com>.

# Important Safety Information

READ AND SAVE THIS OWNER'S GUIDE FOR FUTURE REFERENCE.

This guide contains important safety instructions for the Xantrex Battery that must be followed during installing, operating, configuring, maintaining, and troubleshooting.

Read these instructions carefully and look at the equipment to become familiar with the device before installing, operating, configuring, maintaining, and troubleshooting it. The following special messages may appear throughout this documentation or on the equipment to warn of potential hazards or to call attention to information that clarifies or simplifies a procedure.



The addition of either symbol to a "Danger" or "Warning" safety label indicates that an electrical hazard exists which will result in personal injury if the instructions are not followed.



This is the safety alert symbol. It is used to alert you to potential personal injury hazards. Obey all safety messages that follow this symbol to avoid possible injury or death.

## DANGER

**DANGER** indicates a hazardous situation which, if not avoided, **will result in** death or serious injury.

## WARNING

**WARNING** indicates a hazardous situation which, if not avoided, **could result in** death or serious injury.

## CAUTION

**CAUTION** indicates a hazardous situation which, if not avoided, **could result in** minor or moderate injury.

## NOTICE

**NOTICE** is used to address practices not related to physical injury.

### Please Note

No responsibility is assumed by Xantrex for any consequences arising out of the use of this material.

## DANGER

### HAZARD OF ELECTRIC SHOCK, EXPLOSION, BURN, OR ARC FLASH



⚠ An example of an arc flash event could be a direct short circuit caused by a metallic object such as a tool bridging between the positive and negative of an energized circuit.

- This battery shall be installed and serviced only by qualified personnel.
- Always wear proper PPE (safety glasses and clothing) when working on the Li-ion battery and follow safe electrical work practices according to local codes.
- Do not wear metallic items such as watches or bracelets when working on the battery. Use insulated tools to prevent accidental short circuit.
- Do not install the Li-ion battery module adjacent to any heat source. Keep away from sources of ignition.
- Do not install or operate any of the system devices in a compartment containing flammable materials or in locations that require ignition-protected equipment.
- Do not use in vital, medical, or life-support applications.
- No user-serviceable parts. Do not attempt to open or dismantle the Li-ion battery. If the battery module is damaged, do not touch the toxic electrolyte or powder, and consult your dealer.
- When the battery module is damaged, it can release harmful gases. Ensure the surrounding environment is well-ventilated.
- In case battery content comes in contact with skin or eyes, immediately flush the affected area with large amount of clean water and seek medical help.
- In case of fire, use only a Class ABC (dry chemical) or CO<sub>2</sub> type fire extinguisher. Water can be a dangerous extinguishing medium for energized equipment because of the risk of electric shock.
- Dispose of Li-ion batteries through a local recycling center. Do not mix batteries with other wastes. Contact your local recycling center for proper disposal information.
- Do not crush, puncture, drop, disassemble, or dispose of in fire.

**Failure to follow these instructions will result in death or serious injury.**

## WARNING

### HAZARD OF FIRE, ELECTRIC SHOCK, EXPLOSION, AND PERSONAL INJURY

- Do not expose the Li-ion battery to rain, snow, or liquids of any type. Products are designed for indoor use only.
- Do not step on the battery module.
- Always use proper lifting techniques when handling the battery module. Battery is heavy.
- Do not charge the battery in ambient temperature below freezing.
- Do not disconnect the battery while it is being charged.

**Failure to follow these instructions can result in death, serious injury, or equipment damage.**

## NOTICE

### RISK OF EQUIPMENT DAMAGE

- Do not allow the battery to be depleted.
- Charge the battery module with an approved charger. Contact Xantrex for details.
- Do not charge the battery above the recommended voltage.

**Failure to follow these instructions can result in damage to equipment and may void the warranty.**

## BATTERY DISPOSAL

At the end of the battery's useful life, proper disposal is required. Do not dispose the battery with ordinary household waste. Refer to your local codes for proper disposal of lithium-ion batteries.

## Regulatory Information

This device complies with Part 15 of the FCC Rules and contains a license-exempt transceiver. These limits are designed to provide reasonable protection against harmful interference in a residential environment. This equipment generates, uses, and can radiate radio frequency energy and, if not installed and used in accordance with the instructions, may cause harmful interference to radio communications.

However, there is no guarantee that interference will not occur in a particular installation. If this equipment does cause harmful interference to radio or television reception, which can be determined by turning the equipment off and on, the user is encouraged to try to correct the interference by one or more of the following measures:

- Reorient or relocate the receiving antenna.
- Increase the separation between the equipment and receiver.
- Connect the equipment into an outlet on a circuit different from that to which the receiver is connected.
- Consult the dealer or an experienced radio/TV technician for help.

**FCC ID:** [2AXM8-JDY-23]

## RF EXPOSURE

The device has been evaluated to meet general RF exposure requirements. The device can be used in portable exposure condition without restriction.

## CAUTION

Unauthorized changes or modifications to the equipment could void the user's authority to operate the equipment.

---

# Contents

<b>Important Safety Information</b>	<b>4</b>
Regulatory Information	5
Materials List	7
Before You Begin	7
Installation Tools and Materials	8
Installation Codes	8
<b>Pre-Installation Checklist</b>	<b>9</b>
1.0 Checking the Battery	9
2.0 Choosing a Location for the Battery	9
3.0 Mounting the Battery	10
4.0 Placing the Battery Safely	11
5.0 Installing DC Protections for the Battery	11
6.0 Connecting the Battery Cables	12
<b>Parallel Installation</b>	<b>13</b>
Parallel Installation Steps	14
<b>Communication Installation</b>	<b>17</b>
Deutsch Connector Pin Designations	17
<b>On First Use</b>	<b>19</b>
Initial Setup	19
<b>Operation</b>	<b>20</b>
BMS (Battery Management System) Features	20
The Xantrex App	20
BMS Operations	22
Power Button	22
Cold Ambient Temperature Operation	22
Hot Ambient Temperature Operation	22
Xtend Mode	22
Transport Mode	23
Recovery Mode	23
Recovery Mode for Older Software	24
<b>Troubleshooting and Maintenance</b>	<b>25</b>
Pre-service Checklist	26
Troubleshooting	27
Interpreting Ring LED Patterns on the Battery	29
Battery Maintenance Guideline	31
Battery Storage Guidelines	31
Storage Instructions for Short Durations	31
Storage and Maintenance Instructions for Long Durations	31
<b>Specifications</b>	<b>32</b>
Electrical and Physical Specifications	33
Regulatory Approvals	33

# Introduction

The Xantrex Lithium-ion Batteries are lithium iron phosphate (LiFePO<sub>4</sub>) chemistry batteries used in conjunction with the internal Battery Management System (BMS) unit which protects the batteries and monitors state-of-charge (SOC), voltage, current, and temperature.

Figure 1 Typical System

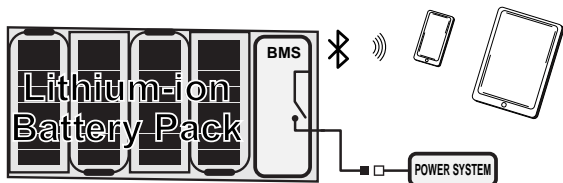

This guide provides instructions on how to safely install, operate, and maintain your Xantrex battery system.

Materials List .....	7
Before You Begin .....	7
Installation Tools and Materials .....	8
Installation Codes .....	8

# Materials List

The Xantrex Battery base package includes the following items.

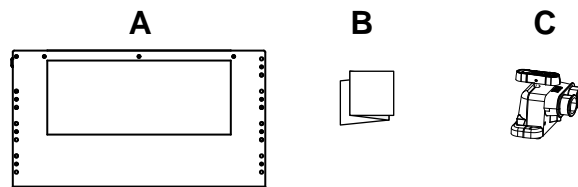

Figure 2 Materials List

A	Xantrex Battery
B	Quickstart guide
C	Rebling connector

**NOTE:** If any of the items are missing, contact Xantrex or any authorized Xantrex dealer for replacement.

**IMPORTANT:** Keep the carton and packing material in case you need to return the lithium-ion battery for servicing. The battery requires special packaging and handling due to the nature of the product.

## Before You Begin

Before beginning your installation:

- Read this entire Installation guide so you can plan the installation from beginning to end.
- Assemble all the tools and materials you require for the installation.
- Review the *Safety Information on page 4*.
- Be aware of all safety and electrical codes which must be met.

### **⚠ WARNING**

#### **ELECTRICAL SHOCK AND FIRE HAZARD**

- All wiring should be done by qualified personnel to ensure compliance with all applicable installation codes and regulations.
- Disable and secure all DC disconnect devices and automatic generator starting devices.
- Do not mount in a zero-clearance compartment.

**Failure to follow these instructions can result in death, serious injury, or equipment damage**

## Installation Tools and Materials

You will need the following to install the Xantrex Battery:

- Torque wrench
- Multimeter
- PPE
- Wire stripper
- Crimping tool

**IMPORTANT:** A torque wrench is required for correct installation of the batteries. A proper torque of  $60\pm 3$  in-lb (or  $6.7\pm 0.35$  N-m) is required for correct installation. If too little torque is applied to the electrical connection hardware, it could come loose during transportation or operation of the batteries. If too much torque is applied the hardware could damage the Rebling connector.

## Installation Codes

Governing installation codes vary depending on the specific location and application of the installation. Some examples include the following:

- The U.S. National Electrical Code (NEC)
- The Canadian Electrical Code (CEC)
- The U.S. Code of Federal Regulations (CFRs)
- Canadian Standards Association/CSA Group (CSA) and the RV Industry Association (RVIA) standards and codes for installations in RVs
- The American Boat and Yacht Council (ABYC) standards and US Coast Guard Regulations (33CFR183, Sub Part I) for Marine installations in the U.S.

It is the installer's responsibility to ensure that all applicable installation requirements are met.



# Pre-Installation Checklist

This section provides a list of pre-installation information about where to install the battery and what protective devices are needed. For your convenience, the checklist is divided into these main points:

- 1.0 Checking the Battery ..... 9
- 2.0 Choosing a Location for the Battery ..... 9
- 3.0 Mounting the Battery ..... 10
- 4.0 Placing the Battery Safely ..... 11
- 5.0 Installing DC Protections for the Battery ..... 11
- 6.0 Connecting the Battery Cables ..... 12

## 1.0 Checking the Battery

Check the battery, included hardware and the box for visible damage including cracks, dents, chips, and deformations. Ensure that the battery including its components are labeled. Check *Materials List on page 7*.

Figure 3 Inspecting the battery

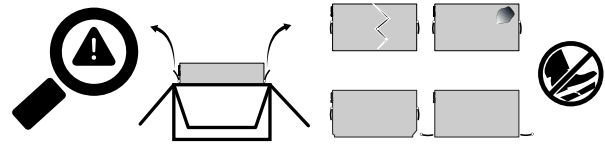

**IMPORTANT:** Contact Xantrex Technical Support immediately if you see visible damages to the battery at +1-800-670-0707 or by email at [customerservice@xantrex.com](mailto:customerservice@xantrex.com).

## 2.0 Choosing a Location for the Battery

### ⚠ WARNING

#### FIRE AND EXPLOSION HAZARDS

- Do not install the Xantrex Battery in compartments containing flammable materials, or in locations that require ignition-protected equipment. This includes any space containing gasoline-powered machinery, fuel tanks, or joints, fittings, or other connections between components of the fuel system. This equipment contains components that tend to produce arcs or sparks.
- Do not cover or obstruct the ventilation openings.
- Do not install the Xantrex Battery in a zero-clearance compartment. Overheating may result.

**Failure to follow these instructions can result in death, serious injury, or equipment damage.**

Select a location for the battery that is stable, clean, cool, dry, and well-ventilated.

- Maintain an ideal operating ambient temperature range of 59 to 77°F (15 to 25°C). Temperatures below this range can reduce system performance. Temperatures above this range can reduce battery cell life and reduce system performance.
- Having a nearby heat source can cause premature wear on the cells inside and earlier disconnects during charge and discharge scenarios where the battery produces some heat internally.
- Having a cooling source pointed at the battery can reduce ideal charging scenarios where the battery should ideally be warmer.

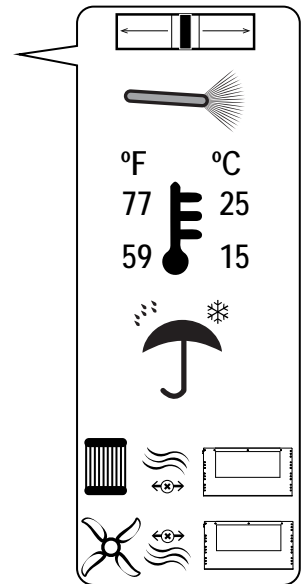

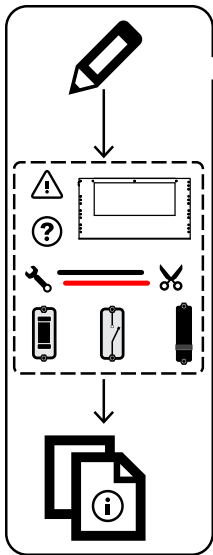

Map out the location of your batteries with a simple wire diagram for pre-planning purposes. The cables between the batteries and all other components should be as short as possible. Having shorter cables will reduce the voltage drop throughout the system allowing better performance and reliability of your power system.

△ In a parallel installation, the battery cables between the parallel batteries must be the same length to reduce voltage differences between the batteries.

- Include all the components on your wire diagram, specifically **DC protection devices** and major connection points.
- Also take into consideration where the other components will be installed in relation to the batteries to account for cable bending as well as ease of access to components once they are installed

## 3.0 Mounting the Battery

### ⚠ WARNING

#### HEAVY EQUIPMENT

Always use proper lifting techniques during handling and installation. A two-person lift may be required to prevent personal injury.

**Failure to follow these instructions can result in death, serious injury, or equipment damage**

#### To mount the Xantrex Battery:

1. Select an appropriate mounting location inside your vehicle or vessel.
2. Mount the battery upright (top label pointing up as shown in the cover page).
  - a. On a horizontal surface such as the floor (ideal)
  - b. On a horizontal surface on battery racks
3. Alternatively, you can mount sideways with the side label pointing up.
4. Ensure that the battery is secured according to local regulations. For securing a marine battery according to local regulations, refer to 33CFR 183.420 and ABYC E-10 - 10.7. For securing an RV battery according to local regulations, refer to ANSI-RVIA LV standard clause 2-3.

Figure 4 Approved Orientations

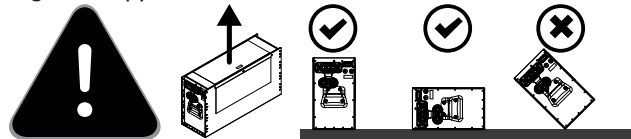

### NOTICE

#### GENERAL PRECAUTION

Do not mount the Xantrex Battery in an area subject to high vibration or physical shock.

**Failure to follow these instructions may reduce the life of the battery.**

## 4.0 Placing the Battery Safely

Position the battery and devices that will connect to the battery in a way that the battery cables avoid sharp bends. Follow the bend radius recommendation below. Aside from battery cables, it is good practice to apply the same bend radius to communication cables as well.

Figure 5 Bending Radius

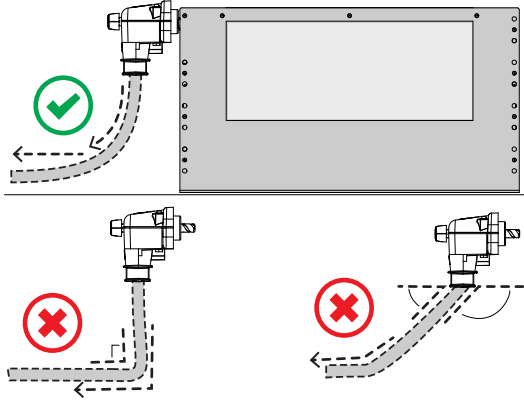

### TIPS:

- A cable's bend radius should be no less than eight (8) times the outside diameter of the cable used. More specific details can be supplied by the cable and wire manufacturer for your specific scenario.
- As it is not normally possible to have such a large bend radius in many installations due to limited space, getting as large a bend radius in as much as the space allows is ideal.

## 5.0 Installing DC Protections for the Battery

Battery protection devices such as properly rated DC fuses, DC disconnect devices, or DC breakers are required to protect the battery from overcurrent scenarios. Here are some basic definitions:

- (A) DC fuses are fuses specifically rated for DC and come with their own fuseholders. Fuses are replaced when they blow. Fuses are installed together with a DC disconnect device. See Figure 6 below.
- (B) DC disconnect devices are binary switches that are either open (OFF) or closed (ON) to stop or allow DC current to flow, respectively.
- (C) DC circuit breakers or simply DC breakers are arc-reducing electromechanical switches that trip (open fast) with overcurrent and are reset (closed) manually. See Figure 7 below.

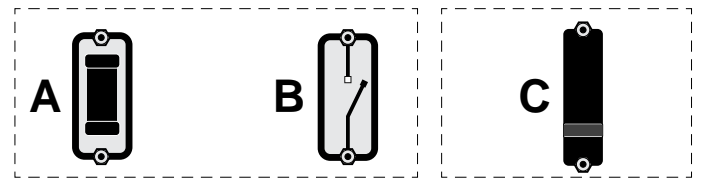

### IMPORTANT:

- The battery protection device should be installed inline with the positive cable of the battery.
- Ideally the protection device should be installed as close as practicably possible to the positive terminals of the battery.
- ⚠ Do not manually operate these protection devices while there are active DC loads and/or charging devices connected to the DC bus. For example, an engine mounted alternator that is connected to the DC bus may sustain damage if the protection devices are closed and opened while in operation. Turn off the engine first.

Figure 6 DC fuse and DC disconnect

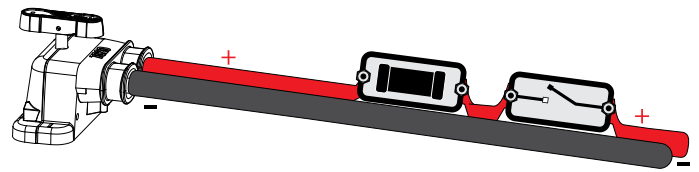
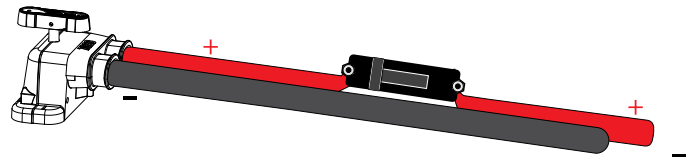

Figure 7 DC breaker



## 6.0 Connecting the Battery Cables

### ⚠ WARNING

#### FIRE HAZARD

Use only stranded, copper wire rated minimum 75 °C (105 °C for marine installations). Make sure all DC connections to the Rebling connector terminals (see *Figure 9* below) are tight to a torque of 60±3 in-lb (or 6.7±0.35 N-m) of force. Loose connections will overheat. Too much torque may crack the Rebling connector terminals.

**Failure to follow these instructions can result in death, serious injury, or equipment damage.**

### NOTICE

#### REVERSE POLARITY

- Check cable polarity at the Xantrex Battery before making the final DC connection. Positive must be connected to positive; negative must be connected to negative.
- Reversing the positive and negative battery cables will blow a fuse in the Xantrex Battery and void your warranty.

**Failure to follow these instructions can result in equipment damage.**

#### To secure the battery cable to the battery terminal using the Rebling connector:

- Make sure the battery is turned off. See *Power Button* on page 22 for instructions on how to operate the Power push button.
  - Ensure all other DC sources have been powered off and disconnected. ⚠ If a charging source is present, operational, and connected to a common bus with the battery, the battery unit will not power down.
  - Disconnect the 12-pin Deutsch connector from the battery.
- Attach using a 5/16" (or 3/8") single hole lug, the negative (-) battery cable to the negative (-) battery terminal of the cable-mounted keyable plug. Review *Figure 9* for proper routing including feeding the cables through the boot and stacking the terminal hardware. Tighten the bolt to 60±3 in-lb (or 6.7±0.35 N-m).
- Install your DC-rated circuit protection device (*Figure 9*) in line with the positive battery cables. The device **MUST** be in open position.
 

**IMPORTANT:** Postpone this step if you are planning a parallel battery installation. See *Parallel Installation Steps* on page 14.
- Attach the protected positive (+) battery cable to the positive (+) battery terminal of the cable-mounted keyable plug. Review *Figure 9* for proper routing including feeding the cables through the boot and stacking the terminal hardware. Tighten the bolt to 60±3 in-lb (or 6.7±0.35 N-m).
- Reassemble the cable-mounted keyable plug by encapsulating the key assembly with the top and boot.
- Remove the red screw tip cover from the key screw.

- Align the connector to its mate on the battery and turn the key lever clockwise to fasten the connection until the lever stops. Do not apply excessive force.

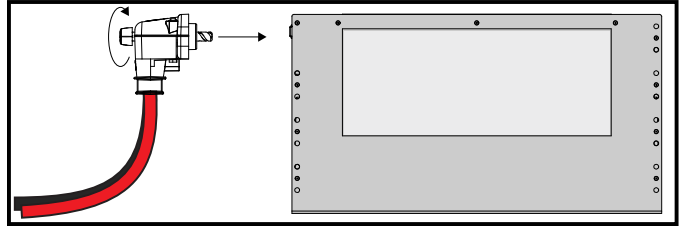

**IMPORTANT:** Postpone this step if you are planning a parallel battery installation. See *Parallel Installation Steps* on page 14.

Figure 8 Cable-mounted keyable plug

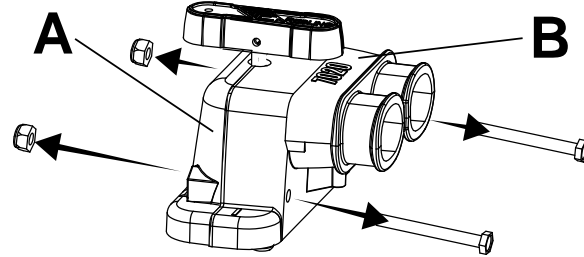

**TIP:** Separate the top (A) from the boot (B) as shown to expose the key assembly which contains the battery terminals.

**NOTE:** The cable-mounted keyable plug doubles as a protective boot that securely attaches the battery cables as an assembly to the battery terminals.

Figure 9 Rebling Assembly

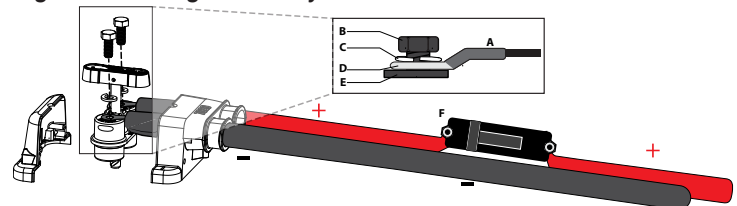

A	battery cable
B	terminal bolt
C	lock washer
D	cable ring lug
E	Rebling connector terminal
F	DC-rated circuit protection device e.g. battery breaker

---

# Parallel Installation

This section provides instructions for installing two batteries in parallel to increase power capacity for robust applications in your RV, truck, or vessel. This sections contains the following topics:

**Parallel Installation Steps** ..... **14**

# Parallel Installation Steps

## IMPORTANT:

- Batteries must be of the same make, model, and age for all batteries connected in parallel.
- Before connecting batteries together, verify independently using a multimeter that each battery is charged to 100% SoC. The open terminal voltage should be within 0.05VDC of each other at the point of connection. This procedure helps ensure that there is minimal current flow and sparking between batteries. Note that you can also use the Xantrex App to provide a reading of SoC information. Nevertheless, a voltage measurement using a multimeter must be taken to ensure there is as little voltage between the terminals as possible.

## NOTICE

### EQUIPMENT DAMAGE

Do not connect batteries in series.

**Failure to follow these instructions can result in equipment damage.**

Figure 10 Parallel batteries

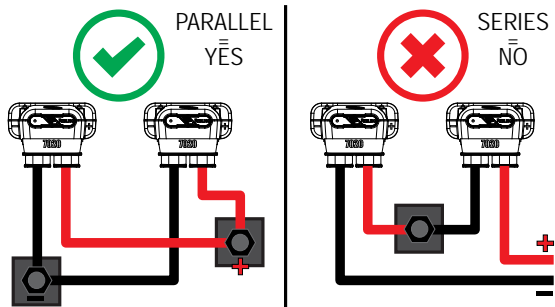

This is for illustration purposes only.

**NOTE:** Keep the cables between batteries and ground cables the same lengths for optimal performance and to ensure equal discharging and charging.

### How to connect batteries in parallel:

## ! WARNING

### FIRE HAZARD

Make sure all DC connections to the common positive bus terminals are torqued according to the bus terminal manufacturer's torque specifications. Loose connections will overheat. Too much torque may damage the terminals.

**Failure to follow these instructions can result in death, serious injury, or equipment damage.**

1. Ensure that DC protection device (such as a DC fuse and disconnect or a DC breaker) is opened or disconnected before starting.
2. Turn OFF all batteries using the power push button on the battery.
3. Install and secure the new batteries in their location.

**NOTE:** With the locations ensure as minimal length, joints, and size variation is made between the cables connecting the terminals of the batteries.

4. Attach the battery cables to the first Rebling connector as instructed in the previous section. Do the same for the second Rebling connector.
5. Connect the battery positive cable end from the first Rebling connector to the common positive bus.

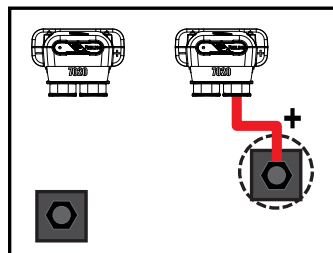

6. Then connect the battery positive cable from the second Rebling connector to the common positive bus.

**NOTE:** If more than two batteries are being connected, ensure a consistent connection method is used for connecting the batteries.

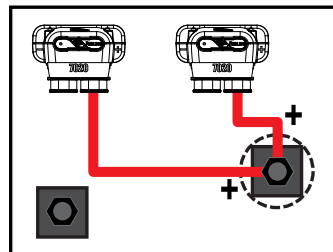

7. Connect the battery negative terminal from the first Rebling connector to the common negative bus.

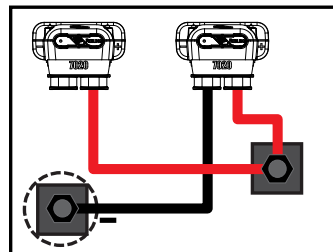

8. Then connect the negative positive cable from the second Rebling connector to the common negative bus.

**NOTE:** If more than two batteries are being connected, ensure a consistent connection method is used for connecting the batteries.

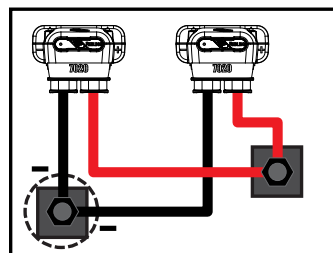

9. Install your DC-rated circuit protection device in line with the common positive bus.

**NOTE:** In parallel installations, one DC-rated protection device may protect only two batteries as shown. In the case of a third or fourth battery, a second protection device must be installed.

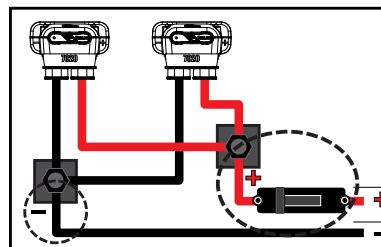

10. Connect the final connection cables from the common negative bus to its termination point on the charging device and from the remaining positive terminal of the DC-rated circuit protection device to its termination point on the charging device.

11. Attach the cable-mounted keyable plug to the battery terminals of the first battery by turning the key lever clockwise. Do the same for the second battery.

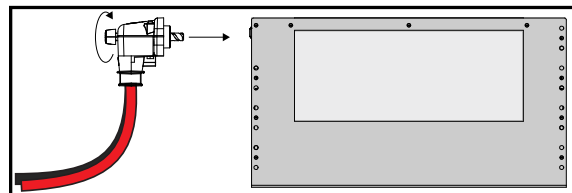

12. Double check all connections for any reverse wiring or incorrectly connected batteries.

13. Ensure all battery terminals are torqued correctly according to specifications.

**NOTE:** Double check all your wiring between batteries for any reversed cables. Check the DC protection device/s for the correct polarity as well.

14. Turn ON all the batteries using the power push button on the battery.

**NOTE:** Wait for all batteries to be fully turned on before proceeding to connect to the main system by closing the DC disconnect or DC breaker. You may observe that when one battery is turned on, other connected batteries will be activated as well.





# Communication Installation

This section contains instructions for other functions that can be used in vehicle systems providing additional performance and usage scenarios. These functions need to be connected through the 12-Pin Deutsch connector. This sections contains the following topics:

**Deutsch Connector Pin Designations** .....17

## Deutsch Connector Pin Designations

The pins should only be connected to devices on an as-needed basis. The Xantrex Battery will function without having the communication ports externally connected to the battery.

The Deutsch connector harness is available using product code (PN: 881-0262-12-02). Contact Xantrex or your Xantrex dealer to order.

Figure 11 Deutsch connector harness

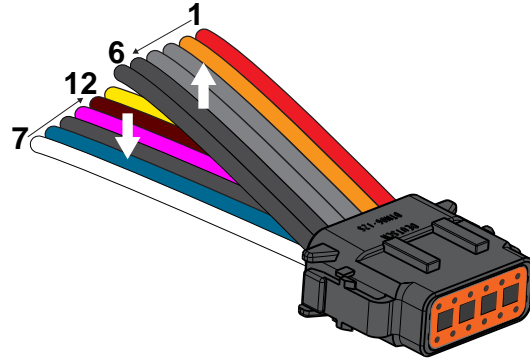

### NOTICE

#### EQUIPMENT DAMAGE

Incorrect wiring and pin assignments may lead to equipment malfunction and/or damage.

**Failure to follow these instructions can result in equipment damage.**

Table 1 Pin reference guide

Pin #	Color	Function	Signal 12 or 24 V nominal according to model	Signal 51 V nominal	Feature Description
1	Red	Engine Running Input	Input High (12/24V)	Input High (12V)	<ul style="list-style-type: none"> <li>Turn the battery from OFF to ON state.</li> <li>If the internal contactor is closed then it shall wait two seconds before Pin 2 shall go high. (If the signal to Pin 1 is removed, Pin 2 shall also drop immediately.)</li> </ul>
2	Orange	Alternator Activation Output (FCC Enable)	Output High (12/24V)	Output High (12V)	If the internal contactor is closed and the battery pack needs to open it (due to a fault), the BMS will set the Alternator Activation output low (0V) to turn off the alternator, wait two seconds, and then open the internal contactor.
3	Grey	Push button wire 1 out (power) or 12V power input for applicable models	Signal (12V, 10mA)	Input 12VDC, nominal, fused 5A	Push Button wire 1 (momentary switch) ⚠ This wire is to be utilized for the Remote Push-button Supply ONLY.
4	Grey	Push button wire 2 in (return)	Return	Return	Push button wire 2 (momentary switch) Power on this pin for certain times and sequences can perform the following actions: <ul style="list-style-type: none"> <li>Power the Unit ON</li> <li>Power the Unit OFF</li> <li>Enter Maintenance Mode</li> <li>Clear Faults</li> <li>Other Maintenance Features.</li> </ul>
5	Black	LED output	Output (12/24V)	Output (12V)	On/Off LED output
6	Black	LED return	Return	Return	Common return for remote on/off LEDs
7	White	CAN High	COMM	COMM	CAN/RV-C High
8	Blue	CAN Low	COMM	COMM	CAN/RV-C Low

Pin #	Color	Function	Signal 12 or 24 V nominal according to model	Signal 51 V nominal	Feature Description
9	Black	Low SOC alarm / Intelligent Generator Start	Output (12/24V)	Output (12V)	<p>Low SOC alarm: This pin will pulse a high signal for one (1) second every twenty (20) seconds when the battery 21% &gt; SOC &gt; 11%. The pin will pulse for one (1) second every five (5) seconds when the battery SOC = 11%. The pin will be held high when the SOC &lt; 10%.</p> <p>Intelligent Generator Start: The intelligent generator start option is only configurable using the SOC gauge (881-0268-07/08). Default operation is when the battery SOC &lt; 20% the signal shall go high until the SOC &gt; 80% of the battery. These thresholds can be changed using the SOC display.</p>
10	Violet	Charge Percentage (control of voltage)	Output PWM	Output PWM	Working in conjunction with Pins 1 and 2. When the engine running signal is detected high and pin 2 has enabled the alternator this pin shall produce a control signal that is compatible with Xantrex Alternators.
11	Brown	Contactator state/Aux output	Output (12/24V)	Output (12V)	High signal when contactor is closed
12	Yellow	Shore Charge Signal input	Input High (12/24V)	Input High (12V)	<ul style="list-style-type: none"> <li>• Turn the battery from OFF state to ON state.</li> <li>• Activates the internal heater and logic in cold environments.</li> <li>• Indicate to the battery that shore power is present on the DC Bus.</li> </ul>

Figure 12 Battery Deutsch connector receptacle

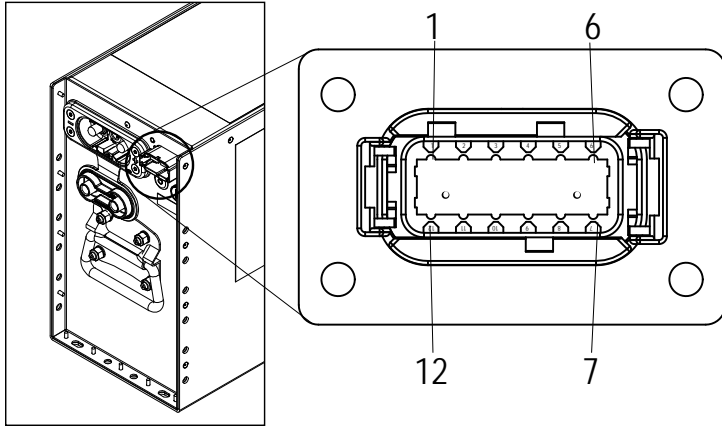

---

# ON FIRST USE

This section includes instructions for the Xantrex Battery's initial setup after installation and prior to operating the battery. This section includes:

Initial Setup .....19

## Initial Setup

Before using the battery (or batteries) for the first time, it is necessary to complete an address claim procedure. This step will ensure the battery (or all batteries) in the RV-C network are properly recognized and configured.

### Address Claim Procedure

- a. **Identify the LED Flash Pattern:** Upon first use, the battery (or batteries) will require an address claim, which is indicated by the battery LED flashing in a pattern of 2 fast flashes followed by 5 slow flashes.
- b. **Prepare the RV-C Network:** Ensure that all batteries in the RV-C network are ON and connected to the network.
- c. **Initiate the Address Claim:**
  - To begin, press the pushbutton on the battery you want to designate as the Parent battery for 1 second. If there is only one battery you only need to observe the next point.
  - The LED will flash briefly and then turn solid, indicating that the address claim for that battery is complete.
  - Repeat this process for all Child batteries in the network, if applicable.

# Operation

This section includes descriptions of the different modes and settings of the Xantrex Lithium-ion Battery. This section includes:

- BMS (Battery Management System) Features** ..... 20
  - The Xantrex App ..... 20
- BMS Operations** ..... 22
  - Power Button ..... 22
  - Cold Ambient Temperature Operation ..... 22
  - Hot Ambient Temperature Operation ..... 22
  - Xtend Mode ..... 22
  - Transport Mode ..... 23
  - Recovery Mode ..... 23
  - Recovery Mode for Older Software ..... 24

# BMS (Battery Management System) Features

Figure 13 Xantrex App Home screen



## The Xantrex App

The battery has a built in BLE (Bluetooth Low Energy ) module for basic communication and troubleshooting with the battery. The BLE module app (the Xantrex App) can be found by searching for "Xantrex App" on the Play Store or the App Store respectively.

## Monitor

Figure 14 Monitor tab

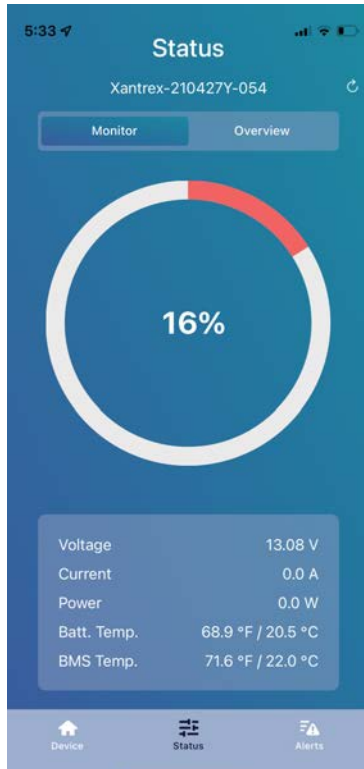

Setting	Description
State of Charge	Measure of the internal amount of charge in the battery
Voltage	The internal voltage of the battery pack
Current	The amount of current flowing through the BMS. (-) Value is a discharge of the battery, (+) Value is a recharge current.
Power	The amount of power flowing through the BMS. (-) Value is a discharge, (+) Value is recharge.
Batt. Temp	The temperature of the cells inside of the battery.

## Overview

Figure 15 Overview tab

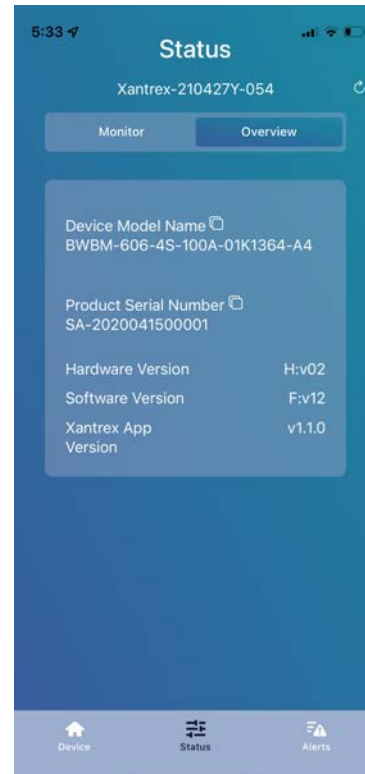

Setting	Description
Device Model Name	Unique hardware ID
Product Serial Number	The serial number of the battery
Hardware Version	Internal revision of the battery
Software Version	Software revision of the BMS.
Xantrex App Version	The revision of the application

## Alerts

The Xantrex App will highlight any event that is detected in the battery or the BMS. The alert will also display a suggestion for correcting the detected event. See *Troubleshooting on page 27*.

## Summary LED Indicator

- ON < 30 Seconds : 100% brightness
- ON > 30 Seconds : 10% brightness (reduced light for comfort)
- Event/Error: Defined by related flash pattern

Pressing the button will return LED to 100% brightness. The same will happen when an event or error is detected.

# BMS Operations

## Power Button



> 2 sec ON



3-5 sec MAINTENANCE



> 10 sec OFF

**Power** push button for ON | OFF | MAINTENANCE. The push button is a multi-function button that must be held down for specified durations to complete each action.

- Press the push button for more than two (2) seconds from OFF | MAINTENANCE mode to turn the battery ON.

ON	Solid on LED, will dim after 30 seconds
OFF	LED off
MAINTENANCE Mode	LED will light up every 5 seconds.
OFF -> ON	Press and hold the button for >2 seconds until the LED lights up; LED going from off to fully bright and back to off every 10 seconds; takes ~45 seconds to turn on. <b>NOTE:</b> If the battery detects an external DC voltage at the DC port, the battery will turn on.
ON -> OFF	Press and hold the button for >10 seconds until the LED turns off after the quick flash pattern; LED will go from off to on and back to off every 0.9 seconds repeatedly.
ON -> MAINTENANCE	Press and hold the button for >~2 seconds or two slow flashes of the LED; You will hear an audible click as the main contactor disconnects.
MAINTENANCE-> ON	Must wait for at least 15 seconds after the battery was put into MAINTENANCE mode before the battery will accept input. Press the button for ~1 second.

- Press and hold the push button for 3-5 seconds during ON mode and this will put the battery to MAINTENANCE mode. This disconnects the cells and reduces the idle power consumption of the battery.
- Press and hold the push button for more than ten (10) seconds during either ON or MAINTENANCE mode and the battery will turn OFF.

⚠ Keep the battery ON after successfully mounting and integrating it into a power system. The system does not need to be put into storage if a consistent charging source is available. If there is no charging source available then follow the directions in the storage section.

**NOTE:** The battery will also turn ON from OFF if a DC voltage is detected at the DC port.

## Cold Ambient Temperature Operation

During cold temperature recharge, if the internal cell temperature is below 32 °F (0 °C) the Xantrex Battery BMS will disconnect the cells from the terminals until the internal temperature has risen above 40 °F (4 °C). This will prevent damage to the cells.

If pin 12 is held high, then the battery shall activate its internal heater when the cell temperature is below 40 °F (4 °C).

**NOTE:** If no charge source is available the battery shall discharge into itself consuming backup time keeping the cells warm if pin 12 is kept high.

## Hot Ambient Temperature Operation

The Xantrex Battery can operate up to 133 °F (55° C) while recharging or discharging the battery.

**NOTE:** Discharging and recharging the battery will produce a limited amount of heat inside the battery. Be aware that in high ambient temperature environments, repeated disconnections are likely, especially if the battery is under high loads or recharge current.

## Xtend Mode

When the battery's SOC drops to 10%, the Xtend mode automatically disconnects the battery from the DC Bus. To reconnect the battery to the DC bus, press the power pushbutton\* for more than 1 sec.

If pin 1 or pin 12 is high when the battery reaches 10% SoC, then the battery will not disconnect and continue discharging.

**NOTE:** If no charge source is available the battery shall discharge into itself consuming backup time.

The battery can also be manually put into a very low power state ideal for storage purposes. The battery automatically goes into OFF state if any of the conditions are met:

If the battery has been in any fault state without any interaction for more than 8 hours excluding the following Faults; B: Serial, C: UT, P: HEAT, and P: IN-H.

**NOTE:** A pin 1 or pin 12 high will override the 8 hour timeout and will not put the battery to OFF state until the pack has reached 85% of nominal voltage (10.2V 12V Nominal, 20.4V 24V Nominal).

\* Also, you may press the pushbutton on the Remote.

## Troubleshooting

If the battery is not responding and has been in OFF mode, an external power source could be required to wake up the battery from a long term storage state. A maximum of 14.6VDC at the battery terminals is required.

Providing a 12VDC power source to pin 12 will also wake the battery.

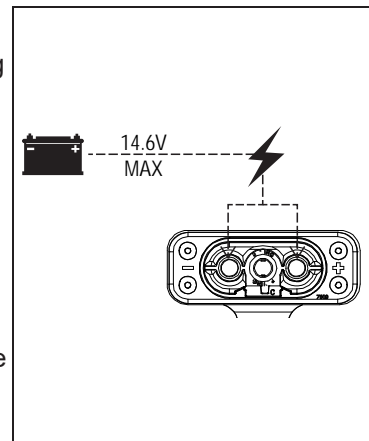

## Transport Mode

Transport Mode is designed to limit the depth of discharge for the battery or batteries when charging availability is uncertain for an extended period, such as when the RV is parked on a dealership lot. This helps preserve battery life and prevent deep discharge.

To enable Transport Mode, an SOC (State of Charge) Display is required. See the table below for a compatible device.

### Follow these steps to activate:

- From the main page, press and hold the **Ok** button until the screen switches to the **App Status** screen.

Figure 16 Access App Status

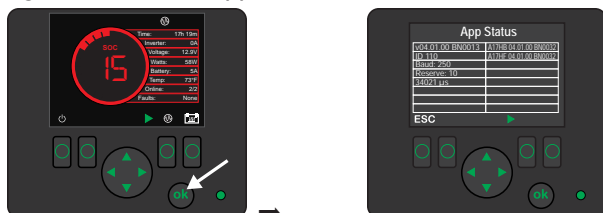

- On the **App Status** screen, press and hold the right arrow button until the **Transport Mode** screen appears.

Figure 17 Navigate to Transport Mode

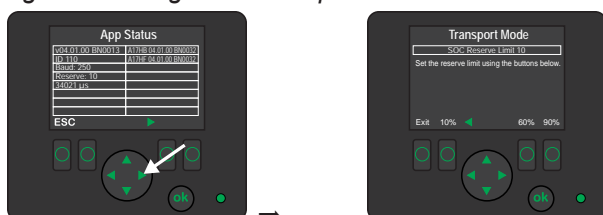

- On the **Transport Mode** screen, choose one of the following low SOC cutoff options: 10%, **60%** (for example), or 90%. The default value is 10%.

Figure 18 Select Low SOC Cutoff

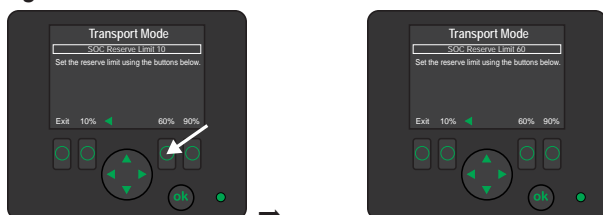

**NOTE:** For extended periods without a reliable charging source or long-term storage, it is recommended to set the cutoff to 60% or 90% to help preserve battery health.

⚠ To exit Transport Mode, set the cutoff to 10%.

## SOC Display Compatibility

Match your battery with a compatible SOC Display device. Contact your Xantrex dealer to order.

Battery Part Number	Compatible SOC Display Part Number
884-0310-12-0016, 884-0410-12-0017, or higher	881-0268-11
884-0310-12-01-XXXX 884-0410-12-01-XXXX up to -0005	881-0268-07
884-0310-12-01-0006, or higher 884-0410-12-01-0007, or higher	881-0268-11
884-0310-12-0001 up to - 0013 884-0410-12-0001 up to - 0013	881-0268-08

## Recovery Mode

**NOTE:** For software version **v04.01.00 BN0000** and up.

If your battery becomes severely over-discharged, it may need to be recovered with a regulated charge from the system itself.

**Recovery Mode** ensures that the battery is charged safely by limiting the amount of incoming current. This mode will automatically engage if shore power is present and there is at least 13V at the battery's DC terminals.

⚠ The battery will exit Recovery Mode automatically.

# Recovery Mode for Older Software

**NOTE:** For software older than version **v04.01.00 BN0000**.

**Follow these steps:**

- a. Place the screen into **Advanced Mode**.

Figure 19 Access Application Settings

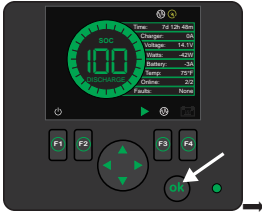

Press and hold the **Ok** button until the screen changes to **Application Status**.

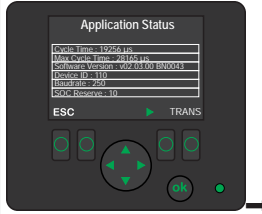

Press the following buttons in succession **[F4->F3->Ok->F2->F1]** until the screen changes to **Application Settings**.

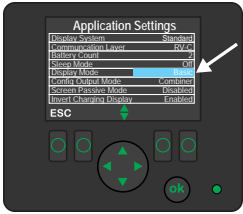

Use the **Down** button to select **Display Mode**, press the **Ok** button and select from **Basic** to **Advanced** using the arrow buttons.

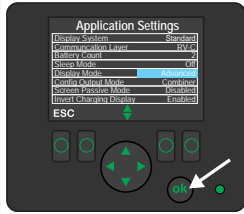

Press the **Ok** button to save the **Advanced** setting.

- b. Navigate to the **Cell Details** screen.

Figure 20 Cell Details screen



Press the **Right** arrow button to move to another screen.

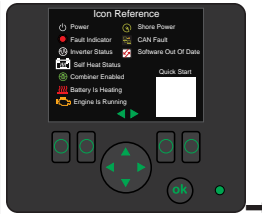

Press the **Right** arrow button.

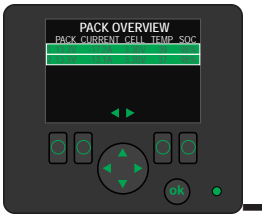

Press the **Right** arrow button.

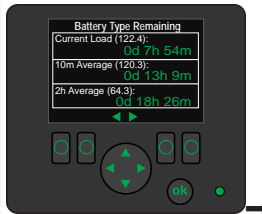

Press the **Right** arrow button.

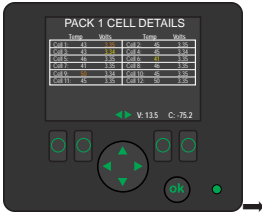

Press the **Right** arrow button.

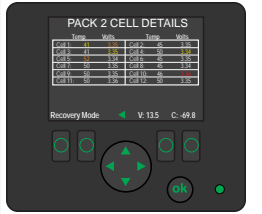

**PACK 2 Cell Details** screen

- c. Select **Recovery Mode** on the required battery.

Figure 21 Enable Recovery Mode

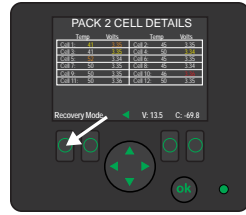

Starting from **PACK 2 Cell Details** screen, press the **F1** button to enable **Recovery Mode**.

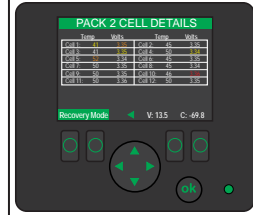

**Recovery Mode** enabled.



---

# Troubleshooting and Maintenance

This section will help you narrow down the source of any problem you encounter. Before contacting customer service, please work through the steps listed in *Pre-service Checklist* on page 26. This section includes:

<b>Pre-service Checklist</b> .....	<b>26</b>
<b>Troubleshooting</b> .....	<b>27</b>
<b>Interpreting Ring LED Patterns on the Battery</b> .....	<b>29</b>
<b>Battery Maintenance Guideline</b> .....	<b>31</b>
<b>Battery Storage Guidelines</b> .....	<b>31</b>
Storage Instructions for Short Durations .....	31
Storage and Maintenance Instructions for Long Durations .	31

# Pre-service Checklist

## **WARNING**

### **ELECTRICAL SHOCK OR BURN HAZARD**

Do not disassemble the Xantrex Battery. It does not contain any user-serviceable parts. Attempting to service the Xantrex Battery yourself could result in an electrical shock or burn.

**Failure to follow these instructions can result in death, serious injury, or equipment damage.**

**NOTE:** To obtain service go to *Contact Information on page 1*.

Prior to obtaining service, see below:

1. Check for any error codes or alert conditions displayed on the Xantrex App. If available, check the connected SOC Display for error codes.
2. As soon as possible, record the conditions at the time the problem occurred so you can provide details when you contact customer service for help. Include the following information:
  - What loads the Xantrex Battery was running
  - What the battery condition was at the time (voltage, etc.) if known
  - Recent sequence of events
  - Any known unusual power factors from the source such as low voltage
  - Whether any extreme ambient conditions existed at the time (temperature, vibrations, moisture, etc.)
3. If your Xantrex Battery is not displaying an error code, check the following to make sure the present state of the installation allows proper operation:
  - Take screen shots of the Xantrex App screens and alert notifications from your smart device.
  - Is the lithium-ion battery located in a clean, dry, adequately ventilated place?
  - Are the battery cables adequately sized as recommended in the guide?
  - Is the battery in good condition?
  - Are all DC connections tight?
  - Are the configuration settings correct for your particular installation?
  - Are all disconnects and DC breakers closed and operable?
  - Are there any blown fuses in the installation, if any?
4. Contact customer support for further assistance. Please be prepared to describe details of your system installation and to provide the model and serial number of the Xantrex Battery.

# Troubleshooting

**NOTE:** If a battery has three of the same error in a span of five minutes, the battery will lockout on the third error detection. The solution is to fully power cycle the battery to clear the lockout error.

Event / Error Description	Solution
Excess charge current	Reduce the charging current to the battery from all charging sources. This includes inverter/chargers, DC-DC chargers, battery chargers, solar charge controllers, alternators, and other higher potential batteries.
Excess battery load(s)	Reduce discharging current from the battery by reducing load consumption. This includes, inverters, DC-DC loads, hotel loads, idle power electronics, and other lower potential batteries.
System Short Circuit	Disable all battery connected systems and check for a system wide short circuit. Do not turn on the battery if a short-circuit is suspected.
Internal battery error	Disconnect the battery from the Deutsche connector and the Rebling connector and then power cycle the battery by turning it OFF and then ON. If the error persists, contact technical support.
Internal temperature sensor error	Power cycle the battery by turning it OFF and then ON. If the error persists, contact technical support.
Cell voltage too high	An internal battery cell has been overcharged in the battery. Remove power by disconnecting all charging sources and wait for the error to resolve by itself. If the error persists check that all charging source maximum voltages are inline with the battery. If the error still persists, reduce charging voltage to the battery by 0.2VDC. If the error persists, contact technical support.
Cell voltage too low	An internal battery cell is over discharged. Disconnect all loads connected to the power system. Check your charging source and be sure to use an approved charging source such as a Xantrex charger or inverter/charger. Connect an external charging source to the battery and turn the battery ON. It should receive a small amount of charge to begin recovering the battery.
Battery voltage too high	The battery has been overcharged. Remove by disconnecting all charging sources and check the charger settings to ensure that a compatible battery type has been configured such as <i>LFP</i> . If the error persists, contact technical support.
Battery voltage too low	The battery has been over discharged. Charge the battery and check the Low Voltage Disconnect setting on the inverter/charger or other loads that have the ability to self disconnect from the DC bus. If the error persists, contact technical support.
Battery is too hot to charge	The battery is too hot to operate correctly during its charge cycle. Decrease the ambient heat in the immediate battery environment, if possible or check for other environmental causes and safely remove the cause.
Battery is too hot to discharge	The battery is too hot to operate correctly during its discharge cycle. Decrease the ambient heat in the immediate battery environment, if possible or check for other environmental causes and safely remove the cause.
Battery is too cold to charge	The battery is too cold to operate correctly during its charge cycle. Increase the heat in the immediate battery environment by safely introducing a heat source. The battery has an internal heating pad that can be activated when pin 12 is held high on the Deutsche connector. Refer to <i>Cold Ambient Temperature Operation on page 1</i> for clarifications.

Event / Error Description	Solution
Battery is too cold to discharge	<p>The battery is too cold to operate correctly during its discharge cycle. Increase the heat in the immediate battery environment by safely introducing a heat source.</p> <p>The battery has an internal heating pad that can be activated when pin 12 is held high on the Deutsche connector. Refer to <i>Cold Ambient Temperature Operation on page 1</i> for clarifications.</p>
Battery temperature differential is too high during charging	<p>Leave the battery at room temperature for several hours. This is caused by the battery having its cells at drastically different temperature measurements. Check for any external heat source that may be affecting the battery temperature.</p> <p>If the error persists, contact technical support.</p>
Battery temperature differential is too high during discharging	<p>Leave the battery at room temperature for several hours. This is caused by the battery having its cells at drastically different temperature measurements. Check for any external heat source that may be affecting the battery temperature.</p> <p>If the error persists, contact technical support.</p>
BMS temperature is too high during charge or discharge	<p>The battery is too hot to operate correctly during its cycle.</p> <p>Decrease the ambient heat in the immediate battery environment, if possible. Or check for other environmental causes and safely remove the cause.</p>
Battery does not turn on with the pushbutton	<p>Apply a voltage of 14.6VDC to the battery terminals for at least 3 seconds.</p> <p>If the battery still does not turn on, contact technical support.</p>

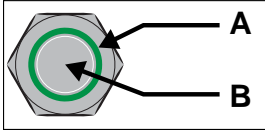

# Interpreting Ring LED Patterns on the Battery

Figure 22 Ring LED on Power Button



A	Ring LED - fast or slow flashing to indicate an event or error
B	Power button

Flash Pattern		SoC Display Error Code			Solution
		Full	Abbreviated	Description	
2	2	Recovery Needed	Recovery	Critical error	Enable recovery mode as described in <a href="#">Xantrex Battery Recovery Procedure (Doc Number: 976-0556-01-01)</a> .
2	3	Contactors Closed	HWR:CNTR Closed	Hardware error (Contactors closed)	Disconnect the 12 pin Deutsch connector and power cycle the battery by turning it OFF and then ON. If the error persists, contact technical support.
2	4	Contactors Opened	HWR:CNTR Open	Hardware error (Contactors open)	Disconnect the 12 pin Deutsch connector and power cycle the battery by turning it OFF and then ON. If the error persists, contact technical support.
2	5	Thermal Warning		High temperature warning	The battery is approaching its thermal limits. Reduce the charge or discharge current and allow the battery to cool.
2	5	n/a	n/a	Address claim required	Follow the steps described in <i>"Initial Setup"</i> on page 19.
2	6	Thermal Fault		High temperature error	The battery has exceeded its thermal limits. Remove all loads and charge sources, and allow the battery to cool.
3	1	BMS Booting	B:Booting	BMS boot in progress	The BMS is booting. Wait for the boot sequence to finish. If the error persists, contact technical support.
3	2	BMS Reboot Required	B:Reboot	BMS boot request	The BMS is requesting to be rebooted. Power cycle the battery by turning it OFF and then ON.
3	4	BMS Communication	B:COM	BMS Communication error	Disconnect the 12 pin Deutsch connector and power cycle the battery by turning it OFF and then ON. If the error persists, contact technical support.
3	5	BMS Failed to Boot	B:Failed	BMS failed boot error	
3	7	BMS Cell Communication	B:Fault	BMS General error	
4	1	Cell Communication	C:COM	Cell Comm error	
4	2	Cell Over Temperature	C:OT	Cell is too hot event	<i>The battery is too hot to operate correctly.</i> Decrease the ambient heat in the immediate battery environment, if possible or check for other environmental causes and safely remove the cause.
4	3	Cell Over Voltage	C:OV	Cell voltage too high event	<i>An internal battery cell has been overcharged in the battery.</i> Disconnect all charging sources and wait for the error to resolve itself. If the error persists, contact technical support.
4	4	Cell Under Temperature	C:UT	Cell is too cold event	<i>The battery is too cold to operate correctly.</i> Increase the heat in the immediate battery environment by safely introducing a heat source.

Flash Pattern		SoC Display Error Code			Solution
		Full	Abbreviated	Description	
4	5	Cell Under Voltage	C:UV	Cell voltage too low event	<i>An internal battery cell is over discharged in the battery.</i> Disconnect all loads connected to the power system. Check your charging source and be sure to use an approved charging source such as a Xantrex charger or inverter/charger.
4	6	Cell Override Exhaust	C:Override	Cell override exceeded	The number of fault-clearing attempts has been exceeded. Ensure the battery is within the normal operating voltage and temperature range.
5	1	Pack Heating	P:Heat	Pack heating in progress	Battery is heating up. FYI only, no action required.
5	2	Pack Self Heating	P:In-H	Pack internal heating in progress	Battery is heating due to internal power. FYI only, no action required.
5	3	Pack Low SOC	P:LowSOC	Low SoC event	Apply either a 12V signal to Pin 1 or Pin 12 then press the Power button or charge the battery thus applying power to the Rebling connector. If SOC Low error occurs at 0% SOC, immediately charge the battery and press the Power button to clear the error (30 seconds).
5	4	Pack Over Current	P:OC	Excess Current event	Disconnect all charging sources or loads to reduce the charging or discharging current from the battery, respectively. See NOTE below.
5	5	Pack Over Voltage	P:OV	Battery voltage too high event	<i>The battery has been overcharged.</i> Disconnect all charging sources and check the charger settings to ensure that a compatible battery type has been configured, that is, <i>LFP</i> . If the error persists, contact technical support. See NOTE below.
5	6	Pack Under Voltage	P:UV	Battery voltage too low event	<i>The battery has been over discharged.</i> Charge the battery and check the Low Voltage Disconnect setting on the Xantrex charger or inverter/charger or the SOC gauge, if available. If the error persists, contact technical support.
6	2	Safety Circuit		Safety override	Battery operating limits have been exceeded. Ensure the battery is within the normal operating voltage and temperature range.

**NOTE:** The battery will automatically reconnect to the DC bus 30 seconds after a Battery Overvoltage or Battery Overcurrent fault. If the fault re-occurs again within 24 hours the battery will lock-out.

An overvoltage condition will automatically reset as long as the cell voltage drops below a safe threshold and the battery detects an RV-C enabled charger on the CAN network (e.g., Freedom XC PRO). If no CAN-enabled charger is detected, the system will enter a lock-out state as described above.

⚠ To clear a lockout, you can either press the pushbutton on the battery or use the SOC display to manually clear the fault.

## Battery Maintenance Guideline

The Xantrex Lithium-ion Battery system is designed to require the least amount of maintenance as possible. The battery and internal BMS are contained in a sealed device and do not require disassembly for maintenance reasons.

In general, to properly maintain the battery, follow the storage guidelines in the following sections.

If the battery/ies are in regular use, then it is recommended that the battery/ies be fully charged a minimum of once per two weeks in order for the BMS to recalibrate its State of Charge (SoC) setting. This process also ensures that the SoC meter maintains its accuracy.

## Battery Storage Guidelines

In order to keep your Xantrex Lithium-ion Battery at peak performance and at its healthiest state, you have to store it according to proper storage conditions and also maintain it with proper care.

Storage can be short term, such as less than one month or long term, such as more than six months.

Table 2 Storage specifications

Term	Temperature	Humidity
< one week	-4 to 113°F (-20 to 45°C)	< 85%RH
< one month	14 to 113°F (-10 to 45°C)	< 85%RH
< six months	50 to 77°F (10 to 25°C)	< 85%RH
> six months *	50 to 77°F (10 to 25°C)	< 85%RH

\* For long term duration storage the battery should be kept in a particular charged state such as, 13.2V, ~50% SoC, and stored at the recommended storage specifications shown above.

## Storage Instructions for Short Durations

1. Fully charge the battery.
2. Turn off the battery (see *Power Button on page 22*).
3. Keep the battery in an environment according to *Battery Maintenance and Storage Specifications*.

## Storage and Maintenance Instructions for Long Durations

1. Reduce the battery state-of-charge (SoC) to 50%  $\pm$ 10% which is approximately 13.2V for a 12V battery or 26.4V for a 24V battery .
2. Turn off the battery (see *Power Button on page 22*).
3. Keep the battery in an environment according to *Battery Maintenance and Storage Specifications*.
4. Every six months maintain the battery by charging it to 100% SoC, then discharging the battery to low voltage cutoff (LVC) level, then charging it back to 50%  $\pm$ 10% SoC.

### NOTICE

#### RISK OF BATTERY DAMAGE

Do not charge the battery in ambient temperature below freezing.

**Failure to follow these instructions can result in damage to the battery and may void the warranty.**

---

# Specifications

**Electrical and Physical Specifications ..... 33**  
**Regulatory Approvals ..... 33**



# Electrical and Physical Specifications

Table 3 Specifications

Feature	884-0310-12   884-0310-12-01	884-0410-12   884-0410-12-01	884-0205-24
Nominal Capacity	310Ah	410Ah	205Ah
Nominal Voltage	12.8V	12.8V	25.6V
Charging Voltage (max)	14.6V	14.6V	28.8V
Float Voltage	14.0V	14.0V	27.6V
Low Battery Cutoff Voltage	11.2V	11.2V	22.4V
Recommended Charge Current*	≤ 250A	≤ 250A	≤ 165A
Max Charge Current* (continuous)	250A	250A	300A
Recommended Discharge Current*	≤ 250A	≤ 250A	≤ 165A
Max Discharge Current* (continuous)	250A	250A	300A
Max Pulse Discharge Current	< 1000A for 1 second and < 500A for 10 seconds	< 1000A for 1 second and < 500A for 10 seconds	< 1000A for 1 second and < 500A for 10 seconds
Internal Impedance	≤ 5mΩ	≤ 5mΩ	≤ 4mΩ
Weight	92lbs (41.7kg)	117lbs (53.1kg)	117lbs (53.1kg)
L x W x H	21.6 x 6.9 x 11.7 in (550 x 175 x 298 mm)	21.6 x 8.9 x 11.7 in (550 x 225 x 298 mm)	21.6 x 8.9 x 11.7 in (550 x 225 x 298 mm)
IP Rating	IP69	IP69	IP69
Charging Temperature	32 – 131 °F (0 – 55 °C)	32 – 131 °F (0 – 55 °C)	32 – 131 °F (0 – 55 °C)
Discharging Temperature	-4 – 131 °F (-20 – 55 °C)	-4 – 131 °F (-20 – 55 °C)	-4 – 131 °F (-20 – 55 °C)

\* Current rating at 25 °C. Current rating of 150A only at the maximum temperature of 55 °C.

Table 4 Product dimensions

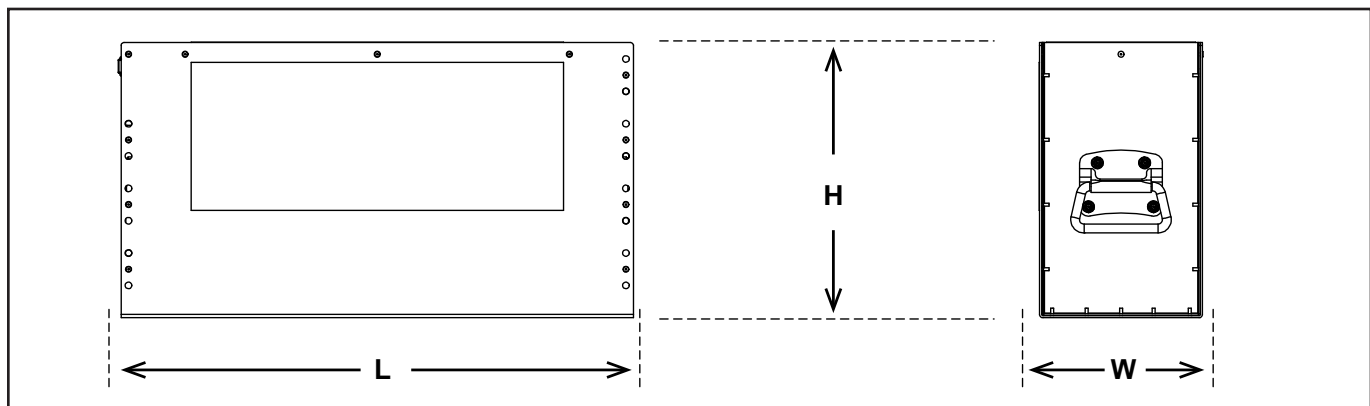

## Regulatory Approvals

Safety	Battery LiFePO <sub>4</sub> Certified Cells: File MH61463; Model GBS-LFP100Ah-E Model 884-0310-12-01; Model 884-0410-12-01 conforms to ANSI/CAN/UL 1973 3rd Edition
--------	--

<https://www.xantrex.com>  
+1-800-670-0707  
+1-408-987-6030