

xantrex

Smart Choice for Power

t 1-800-670-0707 (toll free)
f 1-800-994-7828 (toll free)
CustomerService@xantrex.com
www.xantrex.com

Jazz™ Portable Power 300 C

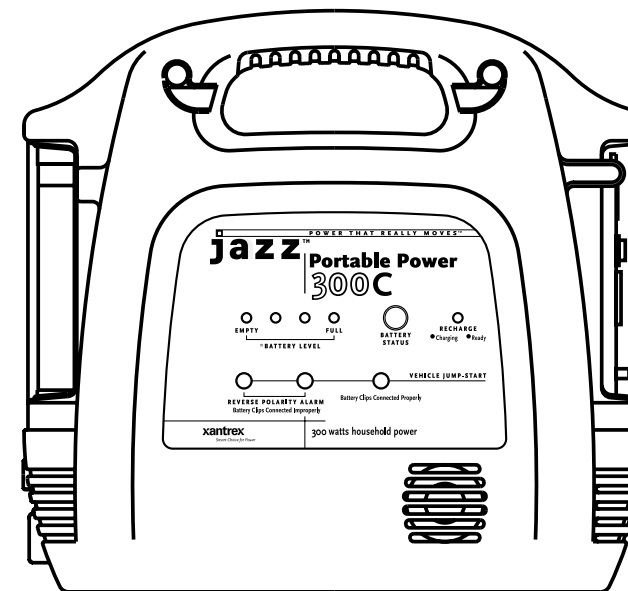

About Xantrex

Xantrex Technology Inc. develops, manufactures and markets leading advanced power electronic and control products for the Distributed, Mobile, and Programmable Power markets. The company's enabling technology converts raw electrical power from any central, distributed, or backup power source into high-quality power required by electronic and electrical equipment. Its products are sold under the Xantrex, Trace, Heart and Statpower brands.

Trademarks

Jazz and Power That Really Moves is a trademark of Xantrex International. Xantrex is a registered trademark of Xantrex International.

Other trademarks, registered trademarks, and product names are the property of their respective owners and are used herein for identification purposes only.

© February 2002 Xantrex International. All rights reserved.

Notice of Copyright

Jazz Portable Power 300 C Owner's Guide © February 2002 Xantrex International. All rights reserved.

Disclaimer

UNLESS SPECIFICALLY AGREED TO IN WRITING, XANTREX TECHNOLOGY INC. ("XANTREX")

(a) MAKES NO WARRANTY AS TO THE ACCURACY, SUFFICIENCY OR SUITABILITY OF ANY TECHNICAL OR OTHER INFORMATION PROVIDED IN ITS MANUALS OR OTHER DOCUMENTATION.

(b) ASSUMES NO RESPONSIBILITY OR LIABILITY FOR LOSS OR DAMAGE, WHETHER DIRECT, INDIRECT, CONSEQUENTIAL OR INCIDENTAL, WHICH MIGHT ARISE OUT OF THE USE OF SUCH INFORMATION. THE USE OF ANY SUCH INFORMATION WILL BE ENTIRELY AT THE USER'S RISK.

Date and Revision

February 2002, Revision 2

Part Number

445-0166-01-01

Contact Information

Phone 1-800-670-0707 (toll free in North America)
1-604-420-1585 (outside North America)

Fax: 1-800-994-7828 (toll free in North America)
1-604-420-1591 (outside North America)

Email: CustomerService@Xantrex.com

Web: www.xantrex.com

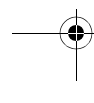
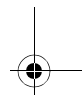
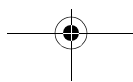
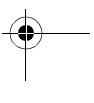
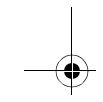
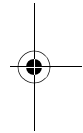
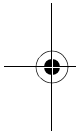
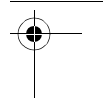
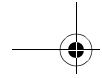
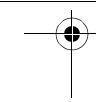

Important Safety Information

The Jazz PP 300 C generates the same AC power as a normal household wall outlet.

Operating the Jazz PP 300 C incorrectly or misusing it may damage the equipment or create hazardous conditions for the user.

Important: Before using your Jazz PP 300 C, be sure to read and save these safety instructions.

Conventions Used

The following conventions are used in this guide.



WARNING

Warnings identify conditions that could result in personal injury or loss of life and appear in this form.



CAUTION

Cautions identify conditions or practices that could result in damage to the Jazz PP 300 C or to other equipment.

Important Safety Information

Warnings and Cautions



WARNING: Shock hazard. Keep Away from Children.

The Jazz PP 300 C generates the same potentially lethal AC power as a normal household wall outlet. Do not insert foreign objects into the AC Outlet, the DC Power Socket, the Jumper Cable Port, or the ventilation holes. Do not expose this product to water, rain, snow, or spray.

Do not open the Jazz PP 300 C except to replace the internal battery. Have a qualified technician complete any service work.



WARNING: Explosion hazard

Do not use this product where there are flammable fumes or gases, such as in the bilge of a gasoline powered boat, or near propane tanks. Do not use this product in an enclosure containing automotive-type lead acid batteries. These batteries, unlike the sealed AGM battery in Jazz PP 300 C, vent explosive hydrogen gas which can be ignited by sparks from electrical connections.

When working on electrical equipment, always ensure someone is nearby to help you in an emergency.

Important Safety Information



WARNING: Heated surface

Ensure at least 2 inches (5 cm) air space is maintained on all sides of the Jazz PP 300 C. During operation, keep away from materials that may be affected by high temperatures such as blankets, pillows and sleeping bags.



CAUTION

Do not connect to the Jazz PP 300 C any AC appliance with the neutral conductor connected to ground.



CAUTION

Do not expose the Jazz PP 300 C to temperatures over 104 °F (40 °C).



CAUTION

The compressor is designed for short term operation only. Operating the compressor over an extended period of time will cause the compressor unit to overheat and may cause damage. Allow the compressor to cool down for 10 minutes after each 10 minutes of continuous operation.

Important Safety Information

Precautions When Working With Batteries



WARNING: Explosion and Fire Hazard

1. Follow all instructions published by the battery manufacturer and the manufacturer of the equipment in which the battery is installed.
2. Make sure the area around the battery is well ventilated.
3. Never smoke or allow a spark or flame in vicinity of the engine or batteries.
4. Be careful not to drop a metal object on the battery or allow a metal tool to simultaneously touch the positive and negative cable ends or battery terminals. It might spark or short-circuit the battery or other electrical parts and cause an explosion.
5. Remove personal metal items such as rings, bracelets, necklaces, and watches when working with a lead-acid battery. A lead-acid battery produces a short circuit current high enough to weld a ring or other similar objects to metal, causing a severe burn.
6. If you need to remove a battery, always remove the positive terminal from the battery first. Make sure all accessories are off so you don't cause an arc.
7. Someone should be within range of your voice, or close enough to come to your aid when you work near a lead-acid battery.
8. Have plenty of fresh water and soap nearby in case battery acid contacts skin, clothing, and eyes.
9. Wear complete eye protection and clothing protection. Avoid touching your eyes while working near batteries.

Important Safety Information

10. If battery acid contacts skin or clothing, wash immediately with soap and water. If acid enters your eye, immediately flood it with running cold water for at least twenty minutes and get medical attention immediately.
11. Keep a supply of baking soda on hand in the area of the batteries. Baking soda neutralizes lead-acid battery electrolyte.

Precautions for Using Rechargeable Appliances

Most rechargeable battery-operated equipment uses a separate charger or transformer that is plugged into an AC receptacle and produces a low voltage charging output.

Some chargers for rechargeable batteries can be damaged if connected to the Jazz PP 300 C.

Do not use the following with the Jazz PP 300 C:

- Small battery-operated appliances like flashlights, razors, and night lights that can be plugged directly into an AC receptacle to recharge.
- Some chargers for battery packs used in hand power tools. These affected chargers display a warning label stating that dangerous voltages are present at the battery terminals.

Note: If you are unsure about using your rechargeable appliance with the Jazz PP 300 C, contact the equipment manufacturer to determine the rechargeable appliance's compatibility with the modified sinewave AC waveform of the Jazz PP 300 C.

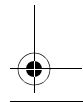
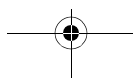
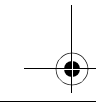
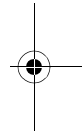
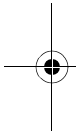
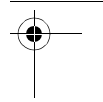
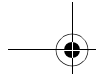
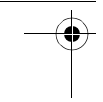

Contents

Important Safety Information

Warnings and Cautions- - - - -	iv
Precautions When Working With Batteries - - - - -	vi
Precautions for Using Rechargeable Appliances - - - - -	vii

1 Introduction

About the Jazz Portable Power 300 C - - - - -	1
Comprehensive Protection - - - - -	2

2 Features

Materials List - - - - -	3
Jazz PP 300 C Features- - - - -	4
Front Panel Detail - - - - -	4
Compressor Unit - - - - -	6
Right Side View - - - - -	7
Left Side View - - - - -	8
Accessories- - - - -	9

3 Operation

Operating Conditions and Guidelines - - - - -	11
Choosing a Location - - - - -	12
Using Jazz PP 300 C for the First Time- - - - -	13
Recharging with the AC Charger - - - - -	13
Operating AC Appliances - - - - -	14
Understanding AC Appliances - - - - -	14

Contents

Operating an AC Appliance	16
Operating 12 Volt DC Appliances	17
Jump-starting a Vehicle or Boat Engine.....	19
Using the Compressor	21
Inflating Tires.....	21
Inflating Small Sports Equipment	22
Connecting to an External Battery	23

4 Maintenance

Battery Maintenance	25
Recharging the Jazz PP 300 C Battery.....	26
Recharging with the AC Charger.....	27
Recharging with the DC Charging Cable	28
Recharging with a Generator's 12 Volt DC Outlet	29
Recharging From a Solar Panel	30
Replacing the Internal Battery	30
Battery Life	30
Obtaining a Replacement Battery	31
Replacing the Battery	31
Replacing the Fluorescent Tubes	33
Replacing the External Fuse	34

5 Troubleshooting

Common Problems	36
Buzz in Audio Equipment	36
Television Interference	36
Troubleshooting Reference	36

6 Specifications

Electrical Specifications	41
Physical Specifications	43

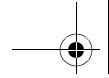

Contents

7 Warranty and Product Information

Warranty Information----- 45

Returning a Product ----- 47

Out of Warranty Service ----- 48

Contacting Xantrex Customer Service----- 49

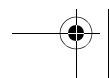
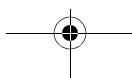
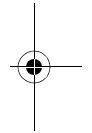
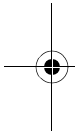

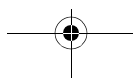
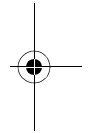
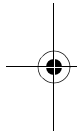
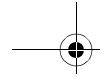

1 Introduction

About the Jazz Portable Power 300 C

Thank you for purchasing the Jazz PP 300 C™, your source for Power That Really Moves™.

Easy to use and designed for years of reliable service, Jazz Portable Power 300 C can run many AC appliances and 12 volt DC appliances whenever you need power for work or play, at home or on the road.

Jazz PP 300 C:

- Powers 115 volt AC appliances
- Powers 12 volt DC appliances
- Jump-starts vehicle or boat engines
- Inflates tires and sporting goods
- Provides fluorescent lighting for emergency use

Comprehensive Protection

Comprehensive Protection

Automatic overload

The Jazz PP 300 C has built-in protection against output overload. If you connect an appliance to the AC Outlet that draws more than 300 watts, or one which draws excessive surge power, the power to the AC Outlet automatically shuts off.

Overheating

The Jazz PP 300 C is protected from overheating. If the inverter exceeds a safe temperature, power to the AC Outlet automatically shuts off.

Low Battery Protection

Low battery protection protects the battery from excessive discharge and possible damage. When the AC Outlet On/Off switch is turned on, an audible alarm alerts you when the internal battery is nearly discharged (10.7 volts).

Jump-start Cables Safety Feature and Reverse Polarity Detection

The Jazz PP 300 C has a special jump-start safety feature that eliminates the sparking that sometimes occurs when jump-start cables are connected to a battery. The Jazz PP 300 C can also detect reverse polarity connection and notifies you with an audible alarm and a red light, Battery Clips Connected Improperly.

2 Features

Chapter 2 describes the main features of the Jazz PP 300 C. Xantrex recommends that you familiarize yourself with these features before operating the unit.

Materials List

Your Jazz PP 300 C package includes the following items:

- Jazz PP 300 C
- Owner's Guide
- AC Charger
- DC Charging Cable
- Jump-start Cables
- Two nozzle adaptors for the compressor
- One sports needle adaptor for the compressor
- Accessory bag

If any of these materials are missing or are unsatisfactory in any way, please contact Customer Service. See "Contacting Xantrex Customer Service" on page 49 of this guide.

Features

Jazz PP 300 C Features

Front Panel Detail

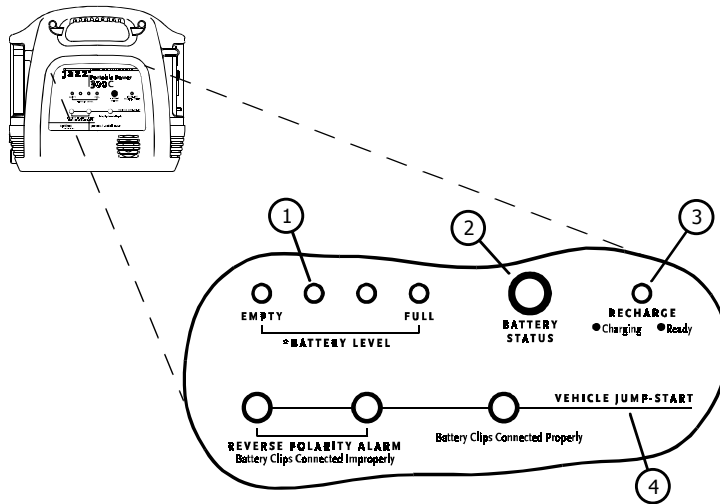

Feature	Description	Note
①	<p>Battery Level indicators illuminate when you press the Battery Status button.</p> <ul style="list-style-type: none"> • 4 lights indicates full charge • 3 lights indicates 3/4 charge • 2 lights indicates 1/2 charge • 1 light (red light): the battery is discharged (empty) and must be recharged promptly. 	<p>Battery Level indicators are accurate only when the Jazz PP 300 C has been disconnected from all appliances and all charging sources for fifteen minutes.</p>

Front Panel Detail

Feature	Description	Note
②	Battery Status Button indicates the charge state of the battery.	Battery Level indicators are inaccurate if you press the Battery Status Button while the Jazz PP 300 C is running an appliance or is being recharged.
③	Recharge Indicator illuminates only when the battery is being recharged through the Charger Input Socket and not through the DC Charging Cable. The light is amber when charging, and green when the battery is fully charged.	Once the battery is fully charged, the charging circuitry switches automatically into its maintenance charge mode.
④	<p>Vehicle Jump-Start Features</p> <ul style="list-style-type: none"> • Reverse Polarity Alarm sounds and the red Battery Clips Connected Improperly illuminates when the jump-start cables are incorrectly connected to the battery terminals. • Battery Clips Connected Properly (Green light) illuminates if jump-start cables are correctly connected to the positive and negative terminals of the vehicle battery being boosted. 	<p>Jazz PP 300 C can detect a reverse polarity condition (caused by incorrectly connecting the jump-start cables to a battery) and automatically stops the flow of current.</p> <p>The special jump-start safety feature prevents sparking at the battery terminals and prevents potential damage to your vehicle's electrical system.</p>
Not shown	Audible alarm (inside the unit) sounds in the event of overheating, low battery protection, and reverse polarity jump-start connection.	

Features

Compressor Unit

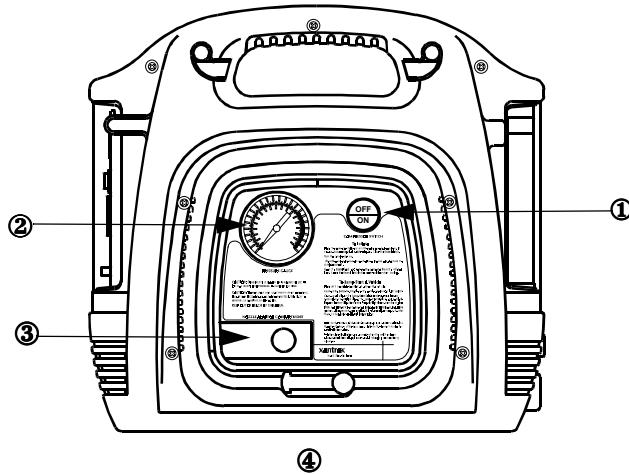

Feature	Description
①	On/Off switch turns the compressor unit on and off.
②	Pressure gauge shows the PSI (lb/in ²)
③	Nozzle Adaptor Compartment
④	Valve connector with connector cord

Right Side View

Right Side View

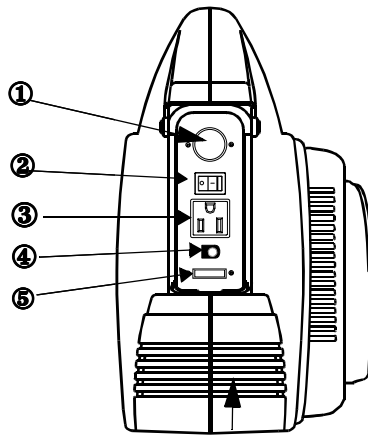

Feature	Description
①	DC Power Socket can: <ul style="list-style-type: none"> • Power 12 volt DC auto or marine appliances • Recharge Jazz PP 300 C from a 12 volt outlet in a vehicle using the DC Charging Cable
②	AC Outlet On/Off switch illuminates when switch is turned On.
③	AC Outlet is a standard 3-prong outlet supplying 115 volts AC power for running an AC appliance.
④	Charger Input Socket for use with the AC Charger supplied
⑤	External replaceable fuse is a 40 amp 32 VDC automotive blade-type fuse which is available at many automotive parts stores.

Features

Left Side View

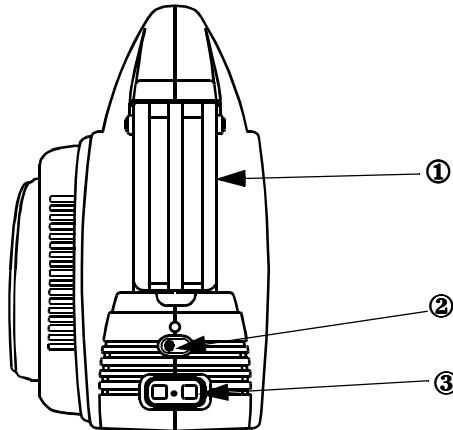

Feature	Description
①	Fluorescent lights illuminate for about 23 hours when the battery is fully charged.
②	Light On/Off Switch has three settings: Off, One Light, and Two Lights.
③	<p>Jumper Cable Port supplies high power DC current. The jump-start cables connect to the Jumper Cable Port when boosting a vehicle's starting battery or when connecting an external battery to the Jazz PP 300 C. The jump-start cable connection is polarized so that the jump-start cable cannot be inserted incorrectly into the Jumper Cable Port.</p> <p>The special jump-start safety feature prevents sparking at the battery terminals and prevents potential damage to your vehicle's electrical system.</p>

Accessories

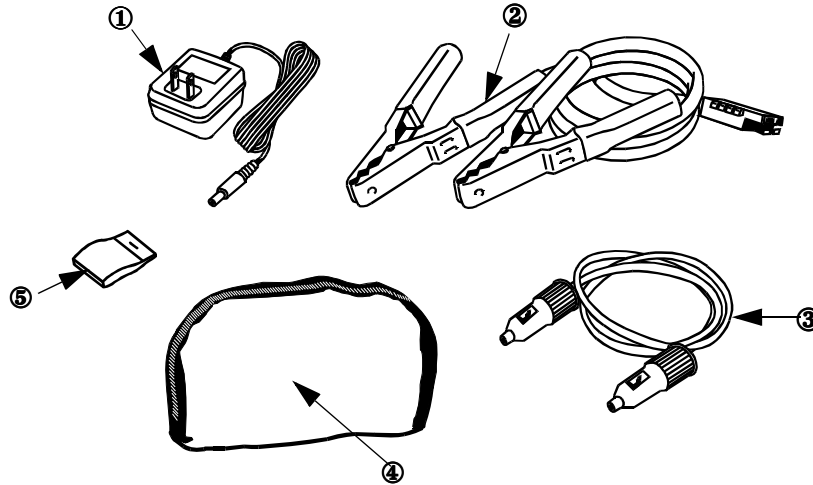

Feature	Description
①	AC Charger lets you recharge the Jazz PP 300 C from a standard AC wall outlet and can only be used to recharge the internal battery of the Jazz PP 300 C.
②	Jump-start cables work with the Jazz PP 300 C to provide a special jump-start safety feature that enables the Jazz PP 300 C jump-start ability only if the Jazz detects that the cables are connected to a battery correctly. If the cable are connected to a battery incorrectly, an alarm sounds and the Battery Clips Connected Improperly light illuminates. The battery to be jump-started must have a terminal voltage of at least 4 volts in order to work with the Jazz PP 300 C.
③	DC Charging Cable lets you recharge the Jazz PP 300 C from a 12 volt system in a car, boat or RV.
④	Accessory bag
⑤	Nozzle packet contains 3 nozzles adaptors (not shown) in the Nozzle Adaptor Compartment.

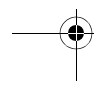
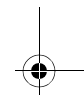
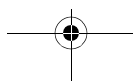
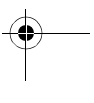
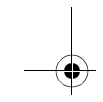
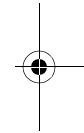
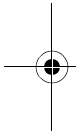
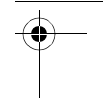
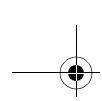
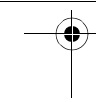

3 Operation

Chapter 3 explains how to operate the Jazz PP 300 C efficiently. This chapter covers:

- Recharging the Jazz PP 300 C for first time use
- Operating AC appliances and 12 volt DC appliances
- Jump-starting a vehicle or boat engine
- Using the compressor
- Connecting to an external battery for additional run time

Operating Conditions and Guidelines



CAUTION

Read all operating instructions before operating the Jazz PP 300 C.

Choosing a Location



CAUTION

Do not use the Jazz PP 300 C to operate any AC appliances or 12 volt DC appliances while recharging with the AC Charger.

The AC Charger may fail if AC appliances or 12 volt DC appliances are operated while the AC Charger is connected.



CAUTION

The Jazz PP 300 C is not intended for use as a UPS (Uninterruptible Power Supply).

Choosing a Location



WARNING: Fire or explosion

The Jazz PP 300 C contains components that tend to produce arcs or sparks. To prevent fire or explosion, do not operate the Jazz PP 300 C in compartments containing batteries or flammable materials, or in locations that require ignition-protected equipment.

The Jazz PP 300 C should be operated only in a location that meets these requirements:

- | | |
|-------------------|--|
| Dry | Do not allow water or other liquids to drop or splash on the Jazz PP 300 C. |
| Cool | Ambient air temperature should be between 32° F and 104° F (0° C and 40° C)—the cooler the better within this range. |
| Ventilated | Leave at least 2 inches (5 cm) clearance around the Jazz PP 300 C for air flow. Ensure that ventilation openings at the front and rear are not obstructed. |

Using Jazz PP 300 C for the First Time

- Safe** Do not operate the unit in the same compartment as batteries or in any compartment capable of storing flammable liquids like gasoline.
- Protected from battery gases** Do not operate the unit where it will be exposed to battery gases. These are very corrosive, and prolonged exposure will damage the Jazz PP 300 C.

Using Jazz PP 300 C for the First Time

Important: Prior to operating your AC appliance or 12 volt DC appliance, ensure that the battery of the Jazz PP 300 C is fully charged. If the battery has been fully discharged, recharging with the AC Charger may take up to 40 hours.

Be sure to recharge the Jazz PP 300 C immediately after purchase. The easiest way to recharge the Jazz PP 300 C is to use the AC Charger. See “Recharging with the AC Charger” on page 13.

If you are interested in other options for recharging, see “Recharging the Jazz PP 300 C Battery” on page 26.

If you keep the Jazz PP 300 C in storage, the battery will discharge over time. Remember to recharge the battery every three months to keep the Jazz PP 300 C operational.

Recharging with the AC Charger

Note: The Battery Level indicators are only accurate when the Jazz PP 300 C has been disconnected from all appliances and all charging sources for fifteen minutes.

Recharging with the AC Charger is a true “plug-in-and-forget” charging method. Xantrex recommends leaving the AC Charger connected when the Jazz PP 300 C is stored.

Operating AC Appliances

To recharge with the AC Charger:

1. Disconnect any 12 volt DC appliances.
2. Turn the AC Outlet On/Off switch to Off, and turn the fluorescent light off.
3. Plug the AC Charger into a standard AC wall outlet.
4. Insert the AC Charger cable end into the Charger Input Socket.

The Recharge indicator changes from amber to green when charging is complete (about 40 hours if the battery is completely discharged).

You can also recharge from the 12 volt outlet or lighter socket in a vehicle. See “Recharging with the DC Charging Cable” on page 28 for details).

Note: Once fully charged, the charging current automatically reduces to a maintenance charge mode, and the Jazz PP 300 C may be left permanently connected to the AC Charger. Also, if your utility power is interrupted, the charging process restarts automatically when the utility power returns.

Operating AC Appliances

Understanding AC Appliances

AC appliances are rated by how much electrical power (in watts) they consume. Jazz PP 300 C can power most appliances within its rating (300 watts 2.6 amps). These appliances include most 115 volt AC appliances that use 300 watts or less.

Some appliances may be damaged if they are connected to the Jazz PP 300 C. See “Precautions for Using Rechargeable Appliances” on page vii.

Some appliances may be difficult or impossible to operate. Some appliances may have high surge requirements or should not be run from the Jazz PP 300 C. See “High Surge Appliances” on page 15.

Run Time on Typical AC Appliances

Note: The fewer watts an AC appliance uses, the longer the Jazz PP 300 C will operate before recharging is required.

Typical AC appliances that can be used on the Jazz PP 300 C are listed in [Table 1](#):

Table 1 AC Appliances and Run Times

AC Product	Watts ¹	Hours ²
Cordless telephone (stand by)	5	37
Home security system	5	37
Clock radio	8	20
Portable stereo	10	15
Fluorescent work light	14	9
Fireplace fan	20	7
Laptop computer	25	6
Table lamp	40	3
Color TV – 13 inches	60	2.5

1. Represents actual power consumption as measured on sample appliances.

2. Operating times assume a fully charged battery and may vary based on mode/brand of product.

High Surge Appliances

The wattage rating of AC appliances is the average power used by the appliance. Appliances such as televisions, computer monitors, and appliances with motors consume much more power than their average rating when they are first switched on.

Operating AC Appliances

Although Jazz PP 300 C can supply momentary surge power greater than 300 watts, some appliances may exceed the capabilities of the Jazz PP 300 C and trigger the inverter's safety overload shutdown circuit. See "Troubleshooting Reference" on page 36 for the reset procedure.

Trouble Appliances

Some appliances may be damaged if they are connected to the Jazz PP 300 C. See "Precautions for Using Rechargeable Appliances" on page vii.

Operating Several Appliances at Once

You can run several AC appliances if the total of all the appliances' rating (in watts) do not exceed 300 watts. You can run appliances using an AC power bar or DC splitter.

Run time, however, will decrease accordingly with the number of appliances being operated and the AC power being consumed.

Operating an AC Appliance

Before operating your AC appliance, ensure that the battery of the Jazz PP 300 C is fully charged. See "Recharging with the AC Charger" on page 13 for details.

To operate an AC appliance:

1. Open the protective covering on the right side of the Jazz PP 300 C. Turn the AC Outlet On/Off switch to the On position.
The switch illuminates to indicate AC power is available at the AC Outlet.
2. Plug the AC appliance into the AC Outlet and turn the appliance on. Jazz PP 300 C will operate most devices rated up to 300 watts.
3. Recharge the Jazz PP 300 C as soon as possible after each use.

Operating 12 Volt DC Appliances

When using the Jazz PP 300 C to operate an AC appliance and the low battery warning sounds, the warning gives you time to shut your AC appliance off before loss of AC power.

If you ignore the warning, the Jazz PP 300 C automatically turns off a few minutes later to prevent battery damage.

In the event of an overload, low battery voltage or overheating, the Jazz PP 300 C automatically shuts down.

Operating 12 Volt DC Appliances

The Jazz PP 300 C can operate 12 volt DC auto, marine, or other portable appliances that draws 12 amps or less from a 12 volt DC power outlet or from a vehicle's lighter socket.



CAUTION Equipment damage

The DC Power Socket does not automatically switch off when the internal battery is discharged. To protect the internal battery against damage resulting from total discharge, Xantrex recommends that the AC Outlet On/Off switch is turned On when using the Jazz PP 300 C to operate a 12 volt DC appliance.

Having the AC Outlet On/Off switch turned On enables the alarm to warn you when the 12 volt DC appliance has nearly depleted the internal battery.

Note: The fewer watts a 12 volt DC appliance draws, the longer the Jazz PP 300 C will operate before recharging is required.

Operating 12 Volt DC Appliances

Typical 12 volt DC appliances that can be used on the Jazz PP 300 C are listed in [Table 2](#).

Table 2 12 Volt DC Appliances and Run Times

12 Volt DC Appliance	Watts ¹	Hours ²
Cellular telephone ³	6	30
Fluorescent light (built into the unit)	8	23
Stereo/CD player	10	17
Portable Cooler	30	3.5

1. Represents actual power consumption as measured on sample appliances.
2. Operating times assume a fully charged battery and may vary based on model or brand of appliance.
3. Represents talk time available from 10 recharge cycles.

To operate a 12 volt DC appliance:

1. Plug the 12 volt DC appliance into the DC power socket on the right side of the unit, and turn the 12 volt DC appliance on (if required).

If the 12 volt DC appliance is drawing more than 12 amps (or has a short circuit defect), the internal circuit breaker of the Jazz PP 300 C shuts the power off to the 12 volt DC appliance. If this occurs, unplug the 12 volt DC appliance, and the internal circuit breaker automatically resets after a few seconds.

2. Fully recharge the Jazz PP 300 C as soon as possible after each use.

As the DC power socket is internally wired directly to the internal battery, extended operation of a 12 volt DC appliance may result in excessive battery discharge. See Caution for “Equipment damage” on page 17.

Jump-starting a Vehicle or Boat Engine

You can use the Jazz PP 300 C to jump-start a vehicle or boat engine that has a 12 volt starting battery using the supplied Jump-Start Cables.

Important: Closely follow these instructions for jump-starting your vehicle as they are different from the instructions supplied with other jump-start products or booster cables.

To jump-start a vehicle or boat engine:

1. Turn off the vehicle or boat ignition, and all accessories.
2. Engage the park or emergency brake and place the transmission in park for an automatic or neutral for a manual.
3. If jump-starting a boat engine, purge the engine compartment and bilge of all fumes before jump-starting.
4. Connect the jump-start cables to the jumper cable port on the left side of the Jazz PP 300 C.
5. Position the Jazz PP 300 C on a flat, stable surface near the battery and away from all moving parts of the engine.
6. Connect the red positive (+) clip of the jump-start cables to the positive (+) terminal of the engine battery.

The battery's positive terminal is usually larger in diameter than the negative terminal. In most vehicles, the battery's positive terminal has a red wire connected to it.

7. Connect the black negative (-) clip of the jump-start cables to the engine block, cylinder head, or other stationary heavy metal part of the motor, or to the negative (-) battery terminal.

If the positive and negative clips are properly connected, the Battery Clips Connected Properly (green light) illuminates.

Jump-starting a Vehicle or Boat Engine

If the clips are not properly connected, the reverse polarity alarm sounds and the Battery Clips Connected Improperly (red light) illuminates.

8. Remove the red positive (+) clip first, and then the black negative clip (-) to cancel the alarm.
9. Repeat steps 1, 5, 6, and 7.

After the clips are properly connected and the Battery Clips Connected Properly (green light) is illuminated, make sure that Jazz PP 300 C and the jump-start cables are clear of belts and fans before attempting to start the engine.



WARNING: Explosion

Do not remove the jump-start cables from the Jumper Cable Port when the positive and negative clips are connected to the vehicle's battery terminals. Removing the jump-start cables from the Jumper Cable Port while they are connected to the vehicle's battery terminals disables the jump-start safety feature and could result in sparking and explosion.

10. Remove the red positive (+) clip and then the black negative (-) clip from the vehicle's battery terminal.
11. Remove the jump-start cables from the Jumper Cable Port.

Important: Recharge the Jazz PP 300 C as soon as possible after each use. See "Recharging the Jazz PP 300 C Battery" on page 26.

Using the Compressor



CAUTION

The compressor is designed for short term operation only. Operating the compressor over an extended period of time will cause the compressor unit to overheat and may cause damage. Allow the compressor to cool down for 10 minutes after each 10 minutes of continuous operation.



CAUTION

Do not leave the compressor unattended while in operation. Keep out of reach of children.



CAUTION

Do not over-inflate article. Follow the recommended pressure on tires and sporting goods.

Inflating Tires

To inflate your vehicle, motorcycle, or bicycle tires:

1. Place the valve connector securely on the tire valve stem, and close the thumb latch.
 2. Turn the compressor on, and inflate your tire to the recommended pressure.
-



CAUTION

Allow the compressor to cool down for 10 minutes after each 10 minutes of continuous operation.

3. Turn the compressor off after appropriate pressure is reached.
 4. Open the thumb latch and remove the valve connector from the valve stem.
-

Using the Compressor

5. Check air pressure with a pressure gauge.

Note: Leave the thumb latch in the open position for storing to relieve pressure on the internal mechanism.

Inflating Small Sports Equipment

You can use the compressor to inflate small sports equipment such as balls (soccer balls and footballs) and small air mattresses.



CAUTION

The Jazz PP 300 C cannot be used to inflate large capacity inflatables such as float tubes, large air mattresses, and inflatable boats. These types of products require extended inflating times which may damage the compressor.

To inflate small sports equipment:

1. Choose the appropriate nozzle adaptor and insert into the compressor's valve connector, if required.
2. Insert the nozzle adaptor into the valve stem, and close the thumb latch, if required.
3. Turn the compressor on and inflate to appropriate pressure.



CAUTION

Allow the compressor to cool down for 10 minutes after each 10 minutes of continuous operation.

4. Turn the compressor off before removing nozzle adaptor from valve stem.
5. Remove nozzle adaptor from valve connector and store in storage compartment.

Note: Leave the thumb latch in the open position for storing to relieve pressure on the internal mechanism.

Connecting to an External Battery

You can extend battery operating times by connecting the Jazz PP 300 C to a larger external battery.

For example, an external 60 amp-hour battery gives approximately three times the operating time of the Jazz PP 300 C internal 20 amp-hour battery.



WARNING: Acid spills

Use a sealed, non-spillable battery for indoor use. Common auto and marine batteries are not suitable for indoor use unless their fumes are vented outdoors. Common auto and marine batteries contain acid, which is hazardous if spilled. Wear eye protection and protective clothing when connecting the Jazz PP 300 C to an external battery.

To connect the Jazz PP 300 C to an external battery using the jump-start cables:

1. Connect the jump-start cables to the Jumper Cable Port on the left side of the Jazz PP 300 C.
2. Connect the red positive (+) clip of the jump-start cables to the red positive (+) terminal of the external battery.
3. Connect the black negative (-) clip of the jump-start cables to the black negative (-) terminal of the external battery.

If the positive and negative clips are properly connected, the Battery Clips Connected Properly (green light) illuminates.

If the positive and negative clips are not properly connected, the Battery Clips Connected Improperly (red light) illuminates and the reverse polarity alarm sounds.

4. Remove the red positive (+) clip first, and then the black negative clip (-) to cancel the alarm.

Connecting to an External Battery

5. Repeat steps 2 and 3.



WARNING: Sparking and Explosion

Do not remove the jump-start cables from the jumper cable port when the positive and negative clips are connected to the terminals of the external battery. Removing the jump-start cable from the jumper-cable port while they are connected to the vehicle's battery terminals will disable the jump-start safety feature and could result in sparking or explosion.

To disconnect the jump-start cables from an external battery and from the Jazz PP 300 C:

1. To disconnect the Jazz PP 300 C from the external battery when the external battery is discharged or no longer needed, remove the red positive (+) clip, and then remove the black negative (-) clip.
2. Remove the jump-start cables from the Jumper Cable Port.
3. Recharge the Jazz PP 300 C as soon as possible after use.

4 Maintenance

Chapter 4 provides information on maintaining your internal battery, recharging options for the internal battery, and replacing user-replaceable parts.

Routine maintenance is required to keep your Jazz PP 300 C operating properly. Occasionally clean the exterior of the unit with a damp cloth to remove the accumulated dust and dirt.



WARNING: Shock hazard

Disconnect all sources of AC power and DC power before doing any type of maintenance.

Battery Maintenance

All rechargeable batteries gradually discharge when left standing, and you need to recharge them periodically to maintain maximum battery capacity. The AC Charger supplied with the Jazz PP 300 C is designed to regulate the charging process, ensuring that the battery is always fully charged but never overcharged. To ensure safe recharging

Recharging the Jazz PP 300 C Battery

and maximum battery life, recharge the Jazz PP 300 C only with the Xantrex supplied chargers or approved battery chargers.



CAUTION

Due to inherent self-discharge, lead acid batteries must be charged at least every 3 months, especially in a warm environment. Leaving a battery in a discharged state, or not recharging every 3 months, may result in permanent battery damage.



CAUTION

Do not attempt to recharge the Jazz PP 300 C battery if it is frozen. Gradually warm the frozen battery to 32 °F (0 °C) before recharging.

Recharging the Jazz PP 300 C Battery

To check the battery's charge level, press the Battery Status button.

Note: Battery Level indicators are only accurate when the Jazz PP 300 C has been disconnected from all appliances and all charging sources for fifteen minutes.

You can recharge the battery using:

- the fully automatic “plug-in-and-forget” AC Charger.
- the DC Charging Cable to recharge from your vehicle as you drive.
- a generator equipped with a 12 volt battery charging outlet.
- a solar panel.

Recharging with the AC Charger

Recharging with the AC Charger is a true “plug-in-and-forget” charging method.

To recharge with the AC Charger:

1. Disconnect any 12 volt DC appliances.
2. Turn the AC Outlet On/Off switch to off, and turn the fluorescent light switch off.
3. Plug the AC Charger into a standard AC wall outlet.
4. Insert the AC Charger cable end into the Charger Input Socket.
5. While the Jazz PP 300 C is recharging, the Recharge indicator is amber. If the battery is completely discharged, a typical recharge may take up to 40 hours. When fully charged, the Recharge indicator changes to green and the Jazz PP 300 C is ready to use.

Once the battery is fully charged, the charging current automatically reduces to a low maintenance level and the Jazz PP 300 C may be left permanently connected to the AC Charger. If your utility power is interrupted, the charging process automatically restarts when power returns.



CAUTION

Do not use the Jazz PP 300 C to operate any AC appliances or 12 volt DC appliances while recharging with the AC Charger.

The AC Charger may fail if AC appliances or 12 volt DC appliances are operated while the AC Charger is connected.

Recharging the Jazz PP 300 C Battery

Recharging with the DC Charging Cable

Using the DC Charging Cable, the Jazz PP 300 C can be recharged while you drive your vehicle.

Important: Although the charge regulation circuitry in Jazz PP 300 C does not operate with this charging method, most vehicle voltage regulators will ensure that the Jazz PP 300 C is not overcharged.



CAUTION

Do not use this recharging method if your vehicle has abnormally high voltage electrical systems that operate above 15 volts DC.



CAUTION

While Jazz PP 300 C is being recharged with the DC Charging Cable from your vehicle, do not operate AC appliances.

To recharge the Jazz PP 300 C while you drive using the DC Charging Cable:

1. While the vehicle engine is running, plug one end of the DC Charging Cable into the DC Power Socket of the Jazz PP 300 C.
2. Plug the opposite end of the DC Charging Cable into the vehicle's lighter socket or 12 volt accessory outlet.
3. Once the Jazz PP 300 C is fully charged or if your vehicle's engine is not running, disconnect the DC Charging Cable from both sockets.

Most of the Jazz PP 300 C's capacity will be restored in four hours while the vehicle engine is running.

Note: The Recharge indicator will not turn green when the Jazz PP 300 C is recharged through the DC Charging Cable.

Recharging the Jazz PP 300 C Battery

Important: Do not leave the Jazz PP 300 C permanently connected to the vehicle's lighter socket or 12 volt accessory outlet.

Recharging with a Generator's 12 Volt DC Outlet



CAUTION

The generator output must be intended for battery charging and have an output of 15 volts or less. An unregulated output or one that exceeds 15 volts DC can damage the battery.

You can recharge the battery of the Jazz PP 300 C using a generator in several ways:

- Using the AC Charger to recharge the Jazz PP 300 C from a generator is possible, but would require extended generator running time.
- Using a generator which has an auxiliary regulated 12 volt DC output designed for charging 12 volt batteries. Most generators are equipped with them. Use this power source for faster charging.
- Using a generator with a lighter socket for its 12 volt output. If the generator is so equipped, then follow the connection instructions in "Recharging with the DC Charging Cable" on page 28.

Refer to the Owner's Guide accompanying your generator for instructions on connecting the generator to a unit like the Jazz PP 300 C.

Most of the Jazz PP 300 C's battery capacity will be recharged in a few hours.

Note: Battery Level indicators are only accurate when the Jazz PP 300 C has been disconnected from all appliances and all charging sources for fifteen minutes.

Replacing the Internal Battery

Recharging From a Solar Panel

Small, unregulated 12 volt solar panels rated to produce a maximum of 2.5 amps (or 30 watts) can be used to charge Jazz PP 300 C through the Charger Input Socket.

You will need to purchase a standard 5.5 mm OD x 2.5 mm ID DC Coaxial (barrel type) connector to mate with the Charger Input Socket.

To recharge with a solar panel:

1. Connect the solar panel's red positive (+) wire to the coaxial plug's inner contact.
2. Connect the solar panel's black negative (-) wire to the plug's outer contact.

Once the connector is inserted into the Charger Input Socket and the solar panel is placed in the sun, Jazz PP 300 C charges automatically just as with the AC Charger. See "Recharging with the AC Charger" on page 27.

It takes about ten hours in direct sunlight to recharge Jazz PP 300 C from a 3 amp solar panel.

Replacing the Internal Battery

Battery Life

The high quality battery used in the Jazz PP 300 C will serve as a reliable power source for years when properly maintained.

To maximize battery life, it is important to recharge the Jazz PP 300 C battery after each use.

Important: Recharge the Jazz PP 300 C fully at least every three months if it is placed in storage or in a vehicle trunk. Store in a location that maintains a temperature range of 32 °F to 86 °F (0 °C to 30 °C).

Replacing the Internal Battery



CAUTION

Discharging the internal battery below 10.0 volts will damage the battery and shorten its life.

Obtaining a Replacement Battery

Replacement batteries are available from stores that specialize in and have a selection of lead acid, AGM (Absorbed Glass Mat) batteries.

Refer to [Table 3](#) for a listing of batteries approved for use with Jazz PP 300 C:

Table 3 Approved Replacement Batteries

Replacement Battery	Where to Buy
Panasonic #LC-X1220P (12 V 20 Ah)	Panasonic: Tel: 1-800-833-9626 web: www.pasc.panasonic.com
	Digi-Key Tel: 1-800-344-4539
EnerSys #NPX-80 (12 V 20 Ah)	EnerSys Tel: 1-800-962-1287 (Eastern US) Tel: 1-800-423-4667 (Western US) web: www.EnersysStationary.com

Replacing the Battery



WARNING: Shock or Electrical Hazard

Read this entire section before disassembling the unit.

Replacing the Internal Battery

Before attempting to replace the internal battery, make sure that:

- You disconnect any charging cables, 12 volt DC appliances, or AC appliances from the Jazz PP 300 C.
- You turn off the AC Outlet On/Off switch and turn off the fluorescent light switch.
- You remove the jump-start cables.



WARNING

If you do not know how to safely remove and install batteries, have this task performed by a qualified service technician.



WARNING

When installing the replacement battery, make sure the battery polarity is correct. Reverse polarity will damage the Jazz PP 300 C and could cause serious injury.

To replace the battery:

1. Place the Jazz PP 300 C upright on a stable and level surface.
2. Unscrew the four fasteners that hold the compressor unit on the back of Jazz PP 300 C. Place the fasteners in the cover for safe keeping.
3. Disconnect the wires on the battery only.

Important: Do not disconnect the wires on the main frame of the Jazz PP 300 C.

4. After removing the old battery, position the new battery close to the back of the Jazz PP 300 C.

Replacing the Fluorescent Tubes

Make sure the positive battery terminal is next to the red positive (+) internal cable and the black negative terminal is next to the black negative (-) internal cable.

5. Securely fasten the bolt, washer, and nut that holds the red positive (+) cable to the positive (+) battery terminal and the black negative (-) cable to the negative (-) battery terminal.
6. Do not overtighten the nut and bolt.
Consult the battery manufacturer for torque specifications.
7. Replace the compressor unit and the four fasteners.
8. Dispose of the old battery in an environmentally responsible manner.

Replacing the Fluorescent Tubes

To replace a fluorescent tube:

1. Turn the light switch off.
2. Remove the clear cover by grasping it on each side at the top and pulling the top of the cover away from the unit.
3. Gently grasp the fluorescent tube and rotate $\frac{1}{4}$ turn to remove it.
4. Insert the replacement tube and rotate $\frac{1}{4}$ turn to lock the tube in place.
5. Reattach the clear cover.

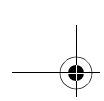

Replacing the External Fuse



Replacing the External Fuse

The replacement fuse is a 40 amp 32 VDC car fuse which can be purchased at any automotive shop. To replace the external fuse:

1. Open the clear cover.
2. Remove the fuse located on the right side of the unit.
3. Insert the replacement fuse. Ensure the replacement fuse is rated at 40 amps.

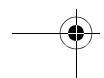
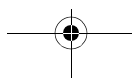
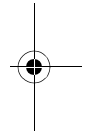

5 Troubleshooting

Troubleshooting will help you identify the common problems than can occur with the Jazz PP 300 C.

Read this chapter before calling Xantrex Customer Service.

If you cannot solve the problem with the Jazz PP 300 C, record the information asked for on “Contacting Xantrex Customer Service” on page 49 and then call Customer Service.

The information recorded on page 47 will help our Customer Service Representatives to assist you better.

Common Problems

Common Problems

Buzz in Audio Equipment

Some inexpensive stereo systems have inadequate internal power-supply filtering and may buzz slightly when powered by the Jazz PP 300 C. The best solution to eliminate the buzzing is to use an audio system with a good quality filter.

Television Interference

The Jazz PP 300 C is shielded to minimize interference with TV signals. If TV signals are weak, you may see interference in the form of lines scrolling across the TV screen. Try one of the following suggestions to minimize or eliminate the interference:

- Use an extension cord to increase the distance between the Jazz PP 300 C and the TV, antenna, and cables.
- Adjust the orientation of the Jazz PP 300 C, television, antenna, and cables.
- Maximize TV signal strength by using a better antenna. Use a shielded antenna cable where possible.
- Try a different TV. Different models vary considerably in their susceptibility to interference.

Troubleshooting Reference



WARNING: Electric shock hazard

Do not remove the cover of the Jazz PP 300 C or disassemble the Jazz PP 300 C except to replace the internal battery. The Jazz PP 300 C does not contain any internal user-serviceable parts and attempting to service the unit yourself could result in electrical shock or burn.

Table 4 Troubleshooting reference

Problem	Possible Cause	Solution
AC appliance will not operate; audible alarm is not sounding.	<p>AC appliance rated more than 300 watts, safety overload has tripped.</p> <p>AC appliance is rated less than 300 watts, high starting surge has tripped safety overload.</p>	<p>Use an AC appliance with a power rating less than 300 watts.</p> <p>AC appliance may exceed Jazz PP 300 C's surge capability. Use an AC appliance with a starting surge within the Jazz PP 300 C surge rating.</p>
AC appliance will not operate; audible alarm is sounding.	<p>Battery has discharged to 10.0 volts.</p> <p>Inverter has overheated due to poor ventilation or excessively warm environmental conditions.</p>	<p>Turn the AC Outlet On/Off switch off and recharge the Jazz PP 300 C.</p> <p>Turn the AC Outlet On/Off switch off and allow the Jazz PP 300 C to cool for 15 minutes or more. Clear blocked fan opening or remove objects covering the unit, then restart the Jazz PP 300 C.</p>
Run time is less than expected.	<p>Internal battery is not fully charged.</p> <p>AC appliance power consumption is higher than expected.</p>	<p>Recharge using the AC Charger, until Recharge indicator is green.</p> <p>Check AC appliance power or wattage rating (or current draw for 12 volt DC appliances) and compare with tables "AC Appliances and Run Times" on page 15 and "12 Volt DC Appliances and Run Times" on page 18.</p>

Troubleshooting Reference

Table 4 Troubleshooting reference

Problem	Possible Cause	Solution
Measured output voltage is too low.	Use of average-reading, AC voltmeter to read output voltage.	Modified sinewave (MSW) output of the Jazz PP 300 C requires true RMS reading meter, such as Fluke 87 series, for accurate measurement.
	Battery is almost fully discharged.	Press Battery Status button and recharge the Jazz PP 300 C as necessary. Battery Level indicators are only accurate when the Jazz PP 300 C has been disconnected from all appliances and all charging sources for fifteen minutes.
The battery clips of the jump-start cables measure zero volts.	No voltage is present at the battery clips of the jump-start cable unless they are properly connected to the external battery.	Connect battery clips of the jump-start cable correctly to the external battery.
Charging light is Off when AC Charger is connected	No AC power at wall receptacle.	Ensure power is available at receptacle.
	AC Charger is faulty.	Replace AC Charger.
Overload shutdown	Appliance power requirements exceed the capacity of the Jazz PP 300 C.	Unplug the appliance and confirm that the appliance's power requirement is 300 watts or less before attempting to restart the appliance.
Extreme overload, 40 amp external fuse opens.	Appliance power requirements greatly exceed the capability of the Jazz PP 300 C.	Replace the fuse with a 40 A, 32 VDC automotive blade-type fuse which is available at many automotive parts stores.
		Reduce appliance power requirements to within power rating of the Jazz PP 300 C.

Table 4 Troubleshooting reference

Problem	Possible Cause	Solution
Over-temperature shutdown	Heat	Turn off the AC Outlet On/Off switch, and let the Jazz PP 300 C cool down.
Alarm sounds	Internal battery is nearly discharged. (10.7 volts). If you ignore this warning, the Jazz PP 300 C automatically switches off when the battery reaches 10.0 volts.	Recharge the Jazz PP 300 C.
Recharge light is amber (indicating recharging) while battery level indicates full.	Battery status reading is incorrect during recharge. Battery Level indicators are only accurate when the Jazz PP 300 C has been disconnected from all appliances and all charging sources for fifteen minutes.	Allow Recharge cycle to go into Ready mode. Unplug the charging sources and any appliances and let the Jazz PP 300 C rest for 15 minutes to get an accurate reading.
Compressor runs but won't inflate.	The valve connector may not be securely on the valve stem. The item being inflated may have a leak.	Check that the valve connector is securely on the valve stem before closing the thumb latch. Check that the item being inflated has no leaks. Check the compressor hose for any breaks or leaks at connections.

Troubleshooting Reference

Table 4 Troubleshooting reference

Problem	Possible Cause	Solution
Compressor runs slowly.	The compressor may have overheated from excessive use.	Unplug the power cord on the Jazz PP 300 C and let the compressor cool down.
	Battery voltage is too low.	Check the condition of the internal battery. The battery may need to be recharged or replaced.

6 Specifications

Electrical Specifications

12 Volt DC Section	
Internal battery type	sealed, AGM (Absorbed Glass Mat) lead acid
Internal battery voltage (nominal)	12 VDC
Internal battery capacity (minimum)	20 Ah
Internal battery CCA rating	200 CCA
DC Power Socket (maximum continuous load)	12 A with automatic reset
Built-in fluorescent lamp (replaceable)	two, 4 W bulbs

Electrical Specifications

AC Power Section	
Output power	
<ul style="list-style-type: none"> • Continuous output power • Five minute AC output power • AC output surge capacity 	250 W 300 W 600 W
Output voltage	115 ± 10 Vac RMS
Output frequency	60Hz ±4 Hz
Output wave form	modified sinewave
No load current draw	<0.20A DC
Input voltage range	10.0 to 15.0 VDC
Low battery alarm	10.7 VDC
Low battery shutdown	10.0 VDC
High battery voltage shutdown	Yes, automatic reset
Over temperature shutdown	Yes, automatic reset
Overload shutdown	Yes, automatic reset
AC output short circuit protection	Yes, automatic reset
Fuse	40 A (user-replaceable)
Operating temperature range	32 °F to 104 °F (0 ° F to 40 °C)
Storage temperature range	32 °F to 86 °F (0 °C to 30° C)

Internal Battery Charging Controller System	
AC Charger bulk charging current	500 mA
Peak charging voltage (nominal)	14.5 V
Charge restart voltage (nominal)	12.9 V
Float charge after full charge is completed (nominal)	1 mA
AC Charger input socket maximum current	2.5 A

Physical Specifications

Compressor	250 PSI (lb/in ²)
Accessories	
Jump-start cables	39 inches (1 m), 8 AWG wire with black and red battery clips
DC charge cable	39 inches (1 m) 18 AWG with male to male lighter plugs
AC Charger input	120 ± 10 Vac, 60 Hz
Nozzle adaptor (for compressor)	two nozzle adaptors
	one sports needle adaptor

Physical Specifications

Depth	7.1 inches (18.0 cm)
Width	12.5 inches (31.8 cm)
Height	11.8 inches (30 cm)
Weight	19.8 lbs (9.0 kg)

Specifications subject to change without notice.

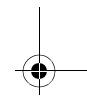
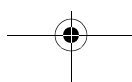
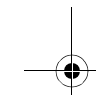
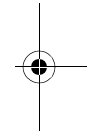
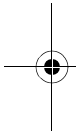
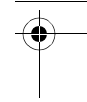
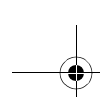
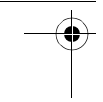

7 Warranty and Product Information

Warranty Information

What does this warranty cover? Xantrex manufactures its products from parts and components that are new or equivalent to new, in accordance with industry standard practices. This warranty covers any defects in workmanship or materials.

How long does the coverage last? This warranty lasts for six months (6) months from the date of purchase. Implied warranties of merchantability and fitness for a particular purpose are limited to six months from date of purchase. Some jurisdictions do not allow limitations on how long an implied warranty lasts, so the above limitation may not apply to you.

What does this warranty not cover? This warranty will not apply where the product has been misused, neglected, improperly installed, physically damaged or altered, either internally or externally, or damaged from improper use or use in an unsuitable environment. Xantrex does not warrant uninterrupted operation of its products. Xantrex shall not be

Warranty Information

liable for damages, whether direct, incidental, special, or consequential, or economic loss even though caused by the negligence or fault of Xantrex. Some jurisdictions do not allow the exclusion or limitation of incidental or consequential damages, so the above limitation or exclusion may not apply to you.

What will Xantrex do? At its option, Xantrex will repair or replace the defective product free of charge. Xantrex will, also at its option, use new and/or reconditioned parts made by various manufacturers in performing warranty repair and building replacement products. If Xantrex repairs or replaces a product, its warranty term is not extended. Xantrex owns all parts removed from repaired products.

Service during warranty? In order to qualify for the warranty, a dated proof of purchase must be provided and the product must not be disassembled or modified without prior authorization by Xantrex. If your product requires warranty service, please return it to the place of purchase along with a copy of your dated proof of purchase. If you are unable to contact your merchant, or the merchant is unable to provide service, contact Xantrex directly:

Phone: 1-800-670-0707 (toll free in North America)

1-604-420-1585 (outside of North America)

Fax: 1-800-994-7828 (toll free in North America)

1-604-420-1591 (outside of North America)

Email: CustomerService@xantrex.com

Web: www.xantrex.com

Returning a Product

You must obtain a Return Material Authorization (RMA) number from Xantrex before returning a product directly to Xantrex.

When you contact Xantrex to obtain service, be prepared to supply the following information:

- Serial number of your Jazz PP 300 C
- Date of purchase
- Information about the use of the Jazz PP 300 C

If you are returning a product from the USA or Canada:

1. Obtain an RMA number and a shipping address from Xantrex. Products returned without an RMA number or shipped collect will be refused.
2. Package the unit safely, preferably using the original packing materials. Include the following with your shipment:
 - The RMA number
 - A copy of your dated proof of purchase
 - A return address where the repaired unit can be shipped
 - A contact telephone number
 - A brief description of the problem
3. Ship the unit to the address provided in Step 1, freight prepaid. Xantrex recommends that you obtain proof of delivery.

Out of Warranty Service

How other laws apply This warranty gives you specific legal rights, and you may also have other rights which vary from jurisdiction to jurisdiction.

For our Canadian customers When used herein “implied warranties of merchantability and fitness for a particular purpose” includes all warranties and conditions, express or implied, statutory or otherwise, including without limitation implied warranties and conditions of merchantability and fitness for a particular purpose.

Out of Warranty Service

If the warranty period for your Jazz PP 300 C has expired, if the unit was damaged by misuse or incorrect installation, if other conditions of the warranty have not been met, or if no dated proof of purchase is available, your inverter may be serviced or replaced for a flat fee.

To return your Jazz PP 300 C for out of warranty service, contact Xantrex Customer Service for a Return Material Authorization (RMA) number and follow the other steps outlined in “Warranty Information” on page 45.

Payment options such as credit card or money order will be explained by the Customer Service Representative. In cases where the minimum flat fee does not apply, as with incomplete units or units with excessive damage, an additional fee will be charged. If applicable, you will be contacted by Customer Service once your unit has been received.

Contacting Xantrex Customer Service

Contacting Xantrex Customer Service

If none of the troubleshooting suggestions work, you will need to call Xantrex Customer Service:

Phone: 1-800-670-0707 (toll free in North America)
1-604-420-1585 (outside of North America)
Fax: 1-800-994-7828 (toll free in North America)
1-604-420-1591 (outside of North America)
Email: CustomerService@xantrex.com
Web: www.xantrex.com

If possible, note the circumstances surrounding the failure below. This information will assist the service technician in diagnosing the problem quickly.

Serial number

Purchase date

Description of problem

Has this problem
happened before?

Appliances running
when problem occurred

Were any AC or 12 volt
DC appliances affected?

Description of indicators
on front panel

