

Installation Guide

140W Xantrex Solar Max Flex Panel Kit

Model Number: 784-0140-01

NOTE: Actual product may be different from what is shown.

Thank you for purchasing the 140W Xantrex Solar Max Flex Panel Kit. The 140W Xantrex Solar Max Flex Panel Kit is a high quality, carbon emissions-free, and sustainable power source for your vehicle such as, recreational vehicle (RV), truck, or boat. It is designed to take solar energy and quietly produce power for your vehicle's DC appliances and store energy to a battery during daylight hours.

The 140W Xantrex Solar Max Flex Panel Kit package includes the following items:

- one pair of Solar Max Flex Panel kit
- one 30A solar charge controller with Inline Fuse
- one pair of Battery Cables with Deutsch Connector/Ring Terminals
- one pair of Jacketed Home Run Cables with Staubli MC4 Connectors
- one Mounting Hardware Kit - screw, cable clamp, flange adapter, warning label, wire tie, edge tape (2x), filling foam (4x)
- one Product Notice with a link to this Installation Guide

NOTE: If any of the accessories, materials, and other items are missing, contact Xantrex or any authorized Xantrex dealer for replacement. See *Contact Information* on the back cover.

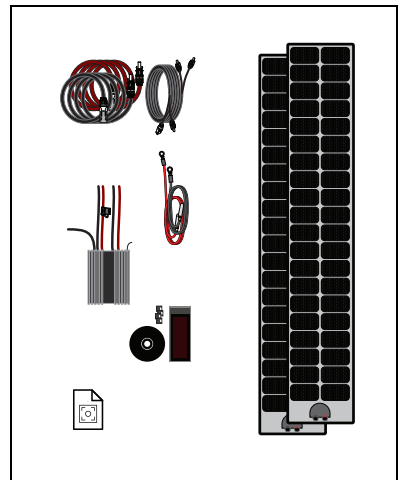

Safety Information

Important Information

READ AND SAVE THIS INSTALLATION GUIDE FOR FUTURE REFERENCE.

Read these instructions carefully and look at the equipment to become familiar with the device before installing, operating, configuring, maintaining, and troubleshooting it. The following special messages may appear throughout this documentation or on the equipment to warn of potential hazards or to call attention to information that clarifies or simplifies a procedure.













The addition of either symbol to a “Danger” or “Warning” safety label indicates that an electrical hazard exists which will result in personal injury if the instructions are not followed.



This is the safety alert symbol. It is used to alert you to potential personal injury hazards. Obey all safety messages that follow this symbol to avoid possible injury or death.

Product Safety Information

-  Before using the 140W Solar Max Flex Panel Kit, read all instructions and cautionary markings on the 140W Solar Max Flex Panel Kit's components, the batteries, and all appropriate sections of this guide.
-  Use of accessories not recommended or sold by the manufacturer may result in injury to persons, a risk of electric shock, or a risk of fire.
-  The 140W Solar Max Flex Panel Kit is designed to be connected to your DC electrical systems. The manufacturer recommends that all wiring be done by a certified PV technician or electrician to ensure adherence to the local and national electrical codes applicable in your jurisdiction.
-  To avoid a risk of fire and electric shock, make sure that existing wiring is in good condition and that wire is not undersized. Do not operate the 140W Solar Max Flex Panel Kit with damaged or substandard wiring.
-  Do not operate the 140W Solar Max Flex Panel Kit if it has been damaged in any way.
-  This 140W Solar Max Flex Panel Kit does not have any user-serviceable parts. Do not disassemble the 140W Solar Max Flex Panel Kit except where noted for connecting wiring and cabling. See your warranty for instructions on obtaining service. Attempting to service the 140W Solar Max Flex Panel Kit yourself may result in a risk of electrical shock or fire.
-  To reduce the risk of electrical shock, disconnect the 140W Solar Max Flex Panel Kit from all devices and or components before attempting any maintenance or cleaning on the 140W Solar Max Flex Panel Kit.
-  To reduce the chance of short-circuits, always use insulated tools when installing or working with this equipment.
-  Remove personal metal items such as rings, bracelets, necklaces, and watches when working with electrical equipment.
-  Do not ground any PV conductors.
-  Do not install the solar panel on top of a residential structure.

Copyright © 2023 Xantrex LLC. All Rights Reserved. All trademarks are owned by Xantrex LLC and its affiliates.

Exclusion for Documentation

UNLESS SPECIFICALLY AGREED TO IN WRITING, SELLER

(A) MAKES NO WARRANTY AS TO THE ACCURACY, SUFFICIENCY OR SUITABILITY OF ANY TECHNICAL OR OTHER INFORMATION PROVIDED IN ITS MANUALS OR OTHER DOCUMENTATION;

(B) ASSUMES NO RESPONSIBILITY OR LIABILITY FOR LOSSES, DAMAGES, COSTS OR EXPENSES, WHETHER SPECIAL, DIRECT, INDIRECT, CONSEQUENTIAL OR INCIDENTAL, WHICH MIGHT ARISE OUT OF THE USE OF SUCH INFORMATION. THE USE OF ANY SUCH INFORMATION WILL BE ENTIRELY AT THE USER'S RISK; AND

(C) REMINDS YOU THAT IF THIS MANUAL IS IN ANY LANGUAGE OTHER THAN ENGLISH, ALTHOUGH STEPS HAVE BEEN TAKEN TO MAINTAIN THE ACCURACY OF THE TRANSLATION, THE ACCURACY CANNOT BE GUARANTEED. APPROVED CONTENT IS CONTAINED WITH THE ENGLISH LANGUAGE VERSION WHICH IS POSTED AT <http://www.xantrex.com>.

NOTE: Visit <http://www.xantrex.com>, click Products, select a Product category, select a Product, and search the Product Documents panel for a translation of the English guide, if available.

Contact Information

Telephone: +1-800-670-0707 / +1-408-987-6030

Web: <http://www.xantrex.com>

Email: customerservice@xantrex.com,

<https://xantrex.com/support/get-customer-support/>

Contents

Basic Installation Steps	4
Safety Instructions	4
Tools and Materials	4
Installation Instructions	4
Solar Panel Maintenance and Care	13
Troubleshooting	14
Specifications	15

Basic Installation Steps

Safety Instructions

Before beginning your installation:

- Read this entire Installation section so you can plan the installation from beginning to end.
- Assemble all the tools and materials you require for the installation.
- Be aware of all safety and electrical codes which must be met.

WARNING

ELECTRICAL SHOCK AND FIRE HAZARD

- The power system must be designed by a certified vehicle solar system designer and installed by a certified solar system technician.
- All wiring should be done by qualified personnel to ensure compliance with all applicable installation codes and regulations.
- Disconnect all power sources.
- Disable and secure disconnect devices.

Failure to follow these instructions can result in death, serious injury, or equipment damage

Tools and Materials

You may need the following tools to install the Solar Max Flex Panel kit:

- Screwdriver
- Socket wrenches
- Utility knife
- DC clamp-on multimeter
- Measuring tape
- Pliers
- Wire cutter
- Safety gloves and eye protection
- Rubber roller
- Primer
- Zip ties (provided as strain-relief devices)
- Flange adapters (provided as needed in mounting)
- 30A solar charge controller (provided)

Installation Instructions

- 1. Plan the power system and prior to installing, check that the panel is producing power.**
 - a. Prepare the multimeter.
 - b. Check out the weather to see if it is sunny.
 - c. Partially unpack the solar panel, expose the cells to the sun and test the output voltage using the multimeter's probes on the solar panel's connectors.
 - d. If the solar panel is functioning properly, the voltage reading should be above 3VDC.
 - e. Draw your power system on paper similar to *Figure 1 on page 5*.

Figure 1 Complete cable schematic of a 2-solar panel power system

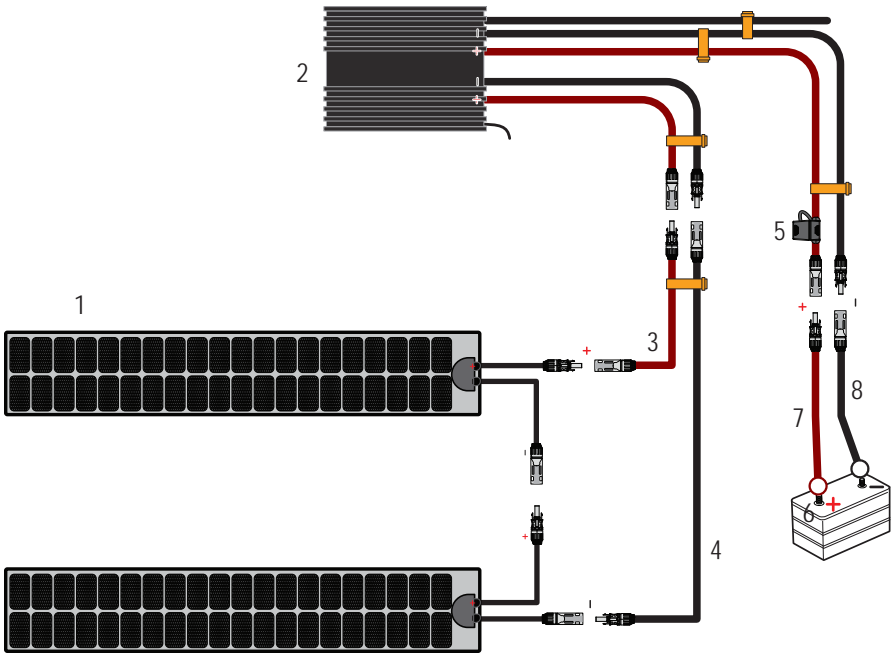

1	Solar panels connected in series (+-+)	5	Inline fuse on red, POS+ cable
2	30A solar charge controller	6	Battery (12V or 24V)
3	PV jacketed home run cable (red, POS+)	7	Battery cable (red, POS+)
4	PV jacketed home run cable (black, NEG-)	8	Battery cable (black, NEG-)

2. Plan and prepare where you would install the solar panels.

PRO TIP: Place end of module aligned to marked line. Peel off around 12 inches of liner from below module, making sure it is aligned. Partially remove and stick the module on in 1 foot increments, making sure module conforms to the surface. Roll out the module with rubber roller or microfiber rag.

NOTICE

GENERAL PRECAUTIONS

- Select a mounting surface on the roof of your vehicle that is firm, thick, rigid, and able to support the solar panel and mounting hardware.
- Surface must be at least 60 °F (15 °C).
- Do not select a roof location within 1 m (3 ft) of the front of the vehicle to reduce wind lift forces during motion.
- Do not mount the solar panel near other roof fixtures that can obstruct direct exposure to sunlight.

Failure to follow these instructions can result in physical damage to vehicles and property.

- a. Unpack the solar panels and prepare all installation tools and materials.
- b. Prepare the mounting surface by removing dust, dirt, and debris.
 - Observe and measure surface obstructions on the installation surface, if any.
 - Determine which areas need extensive cleaning.
 - Use the filling foams (provided in the kit), if the installation surface is ridged and not flat. Contact your dealer for further suggestions.
- c. Apply a cleaner to the mounting surface.
 - Soak a microfiber rag with the chosen cleaner.
 - Choose isopropyl alcohol, acetone, or a residue-free industrial surface cleaner/degreaser.
 - Remove any substance that could hinder adhesion.
 - If needed, apply the cleaner directly to the surface.
 - Ensure there is no residue left on the mounting surface.
- d. Mark mounting location of panel.

3. Mount the solar panel.

- Hold module in place, then remove several inches of liner from one end.
- Apply even pressure only on top of the areas where there is the 3M VHB tape underneath the solar panel for proper bonding of the 3M VHB tape to the mounting surface. It is ideal to use a roller or the palm of your hands to apply pressure.
- Be careful not to apply hard pressure on the solar cells that may lead to damage.

⚠ WARNING

ELECTRIC SHOCK AND FIRE HAZARD

Do not ground any PV conductors.

Failure to follow these instructions can result in death, serious injury, or equipment damage.

TIP: Once applied to a surface, the 3M™ VHB™ tape, which is a high-strength, double-sided acrylic adhesive tape, cannot be easily removed without damaging both the solar panel and the mounting surface. For more information, visit the 3M website.

IMPORTANT: Follow the recommendations illustrated in Figure 2 and succeeding Figures.

Figure 2 Precautions



NOTICE

GENERAL PRECAUTIONS

- Do not bend more than 30° when handling and mounting the solar panel.
- Do not step on the solar panel.
- Do not mount the solar panel near other roof fixtures that can obstruct direct exposure to sunlight.
- Select the mounting area carefully and mark the exact and intended location of the solar panel.

Failure to follow these instructions can result in physical damage to vehicles and property.

Figure 3 Adhesive strips on the panel's backside

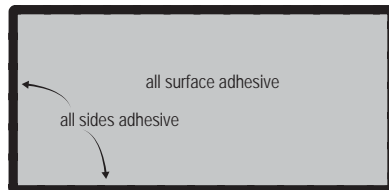

The backside of the Solar Max Flex Panel kit has 3M VHB tape strips already applied around the perimeter of the panel.

- Use the edge tape (provided in the kit) to apply all around the perimeter edge of the panel for a tighter seal. See Figure 4 for an illustration.

Figure 4 Adhesive placement depending on surface

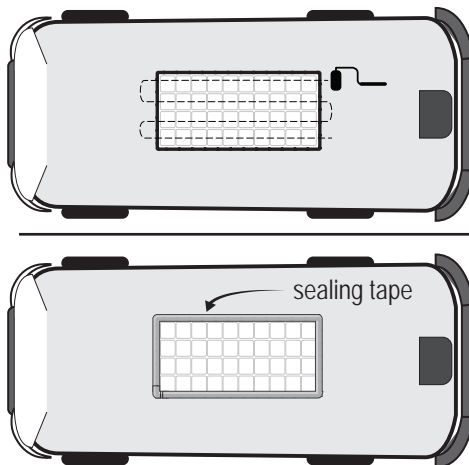

For illustration purposes. The solar cells are shown as perspective only. Do not apply the adhesive tape on top of the solar cells. The adhesive tape must be applied on the back side of the panel and onto the mounting surface.

4. Mount the Charge Controller.

The charge controller is best mounted in a location away from direct heat, water, salt, snow, ice, and debris.

- a. Mount the unit.
- b. Ensure the heat fins have sufficient air flow.
- c. Use the charge controller flange to create a hole template so you can pre-drill the mounting holes.

Figure 5 Charge Controller

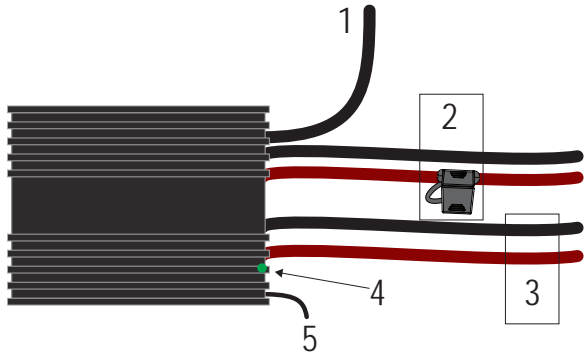

1	Communication port (do not cut or remove)	4	LED lights
2	Battery cables (Power output) positive (+) with fuse & negative (-)	5	Thermistor probe (do not cut or remove)
3	PV cables (Solar Input) positive (+) & negative (-)		

Make sure the in-line fuse (in item 2 above) is connected on the (+) side of the battery side of the charge controller. If you have a busman disconnect, make sure it is not near an area where it can disconnect by touching other cables or components.

- d. Use an appropriately sized self-tapping screw (4x) to attach the solar charge controller to the wall.

NOTICE

MOUNTING TO A WALL WITH NO BACK ACCESS

If drilling to a wall is not possible, use flange adapters to secure the solar charger to the wall.

Failure to follow these instructions can result in equipment damage.

Figure 6 Flange adapter

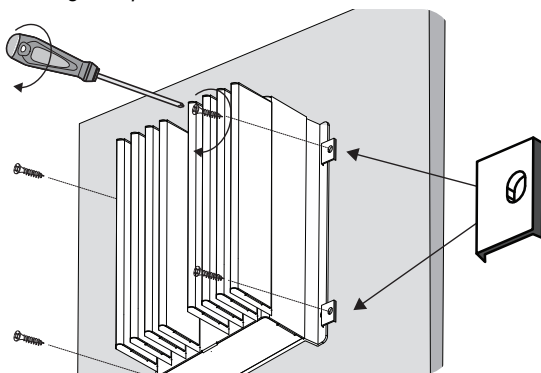

- e. Use the provided flange adapters (4x) to clamp the solar charge controller to the wall.

5. Connect the DC cables.

NOTICE

REVERSE POLARITY

Check polarity at all terminals before making the final DC connection. POS(+) (red) must connect to charge controller POS (+) (red); NEG(-) (black) must connect to charge controller NEG (-) (black).

Failure to follow these instructions can result in equipment damage.

- a. Cover the solar panel with a blanket (or the packaging box) to de-energize it.
- b. Before connecting the cables, be sure to review the information below regarding where to place strain-relief devices.

NOTICE

STRAIN-RELIEF REQUIREMENT

Using the diagram below, when you start inter-connecting the cables make sure to install a strain-relief device (a zip tie) on the points indicated.

Failure to follow these instructions can result in equipment damage.

Figure 7 Strain-relief points

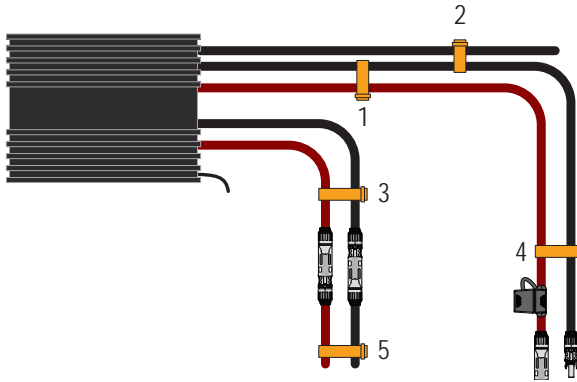

1	Install approximately 2 to 4 inches from the solar charger to tie the battery cables together.	4	Install approximately 5 to 7 inches from the solar charger to tie the battery cables together.
2	Install approximately 5 inches from the solar charger to tie the negative (-) battery cable with the communication cable.	5	Install approximately 8 to 10 inches from the solar charger to tie the connecting PV cables together.
3	Install approximately 4 inches from the solar charger to tie the PV cables together.	⚠	Do not tie the BTS cable to any of the DC cables.

- c. Connect the red pos (+) and black neg (–) battery cables to the charge controller.
- d. Route the battery cable inside the vehicle and connect the red pos (+) and black neg (–) battery cables to the respective battery terminals.
- e. Secure all cables with clamps (and/or cable ties) and additional strain-relief as necessary.
- f. Connect the red pos (+) and black neg (–) PV cables to the solar panel using the MC4-type connectors.
- g. Route the PV cables through the roof entry point and connect the red pos (+) and black neg (–) PV cables to the charge controller.
- h. Clear the roof and the cable routes of tools and other debris that may have been left during installation.

6. Operate and maintain the system.

- a. Remove the blanket (or the packaging box) covering the solar panel to start energizing the solar panel.
- b. Refer to *Solar Panel Maintenance and Care on page 13* for best practices.

Solar Panel Maintenance and Care

Although a well designed vehicle-mounted solar system requires minimal maintenance, it is highly recommended to perform an inspection and cleaning of the solar panels during the warranty period. This helps to ensure optimal system performance and reliability through a few simple steps.

Visual Inspection Perform a visual inspection of the solar system on a monthly basis to identify if there are any visual defects or improper connections.

- Check for any sharp objects on the solar panel surface.
- Check for any signs of corrosion or burnt hotspots around the solar cell and backsheet area.
- Check that the solar panel is clear of any shading by any foreign material or unwanted obstacles. Just a small amount of shade on the solar panel surface can cause significant power output loss.
- If the solar panel has slight discoloration over a period of usage, this is considered normal for solar panels that use an anti-reflection coating laminate.

Cleaning Solar Panels The power output of a solar panel is proportional to the amount of sunlight that reaches the solar cells. Therefore, any build-up of dust or dirt on the surface of the solar panel will result in a loss of power. This is a trade-off between the maximizing the power output of the solar panel versus the cost and time to perform regular cleaning.

⚠ Do not clean solar panels if there is broken plastic material or exposed wiring because this creates a risk for electric shock.

⚠ Do not step or kneel on the solar panel during cleaning.

- Check the solar panel periodically during seasons that the vehicle is in-use. If there is a build-up of dust or dirt on the surface of the solar panel, it is recommended to clean it.
- Clean the solar panel in the early morning or early evening when the solar panel is cooler, especially in hot regions. This will reduce the risk for electrical and thermal shock.
- Clean using a soft cloth together with clean water and mild detergent or soap.
 - Make sure there is no soap residue remaining after cleaning.
 - Avoid using water with high mineral content that may leave deposits on the solar panel surface.
 - Do not use abrasive materials to clean the solar panel.
 - Do not use chemicals to clean the solar panel.
 - Do not pressure wash the solar panel.

Troubleshooting

WARNING

ELECTRICAL SHOCK HAZARD

If the in-line fuse on the 10AWG positive (+) battery cable blows, replace with a 30A/32V green ATC blade fuse.

Failure to follow these instructions can result in death, serious injury, or equipment damage.

NOTE: To obtain service go to *Contact Information on page 1.*

Problem	Possible Cause	Solution
Battery does not get charged even when sunlight is present.	Solar panel is partially shaded or there is insufficient sunlight.	Move the vehicle or vessel so the whole solar panel is exposed to direct sunlight.
	Loose or no DC cable connections.	Connect DC cables to the battery and solar panel and tighten terminal connections.
	Fuse is blown.	Replace the blown fuse with a 30A/32V green ATC blade fuse.

Specifications

NOTE: Specifications are subject to change without prior notice.

140W Xantrex Solar Max Flex Panel Kit

Part number	784-0140-01
Dimensions	47.01 x 14.69 in (1194 x 373 mm)
Cell type	Monocrystalline PERC
Top layer	ETFE
Junction box	IP67
Connector	MC4
Maximum power at STC*	140 W
Maximum power voltage	65 V
Maximum power current	2.2 A
Open circuit voltage	72.8 V
Short circuit current	2.4 A
Maximum system voltage	600 VDC
Operating temperature	-40 °C to +85 °C
Temperature coefficients of Pmax	-0.39%/°C
Temperature coefficients of Voc	-0.30%/°C
Temperature coefficients of Isc	+0.06%/°C

* Standard Test Conditions (STC): Irradiance: 1000W/m², Cell Temperature: 25°C, Air Mass: 1.5

MPPT Charge Controller

Battery Nominal Voltage	12/24VDC
Rated Charge Current	30A
Nominal PV Power	195W @ 12V 390W @ 24V
Enclosure	IP68
Cable Terminal	14AWG/2.5mm ²
Dimensions	5.91 x 3.68 x 1.23 in (150 x 93.5 x 32.7 mm)
Unit weight	1.6 lbs.(740 g)

xantrex™ SOLAR



+1-800-670-0707

+1-408-987-6030



customerservice@xantrex.com

<https://xantrex.com/support/get-customer-support/>



<http://www.xantrex.com>